

BROADCAST NEWS



Vol. No. 113
MAY 1962



KSTP

Television City - NBC



IN RADIO'S WONDERFUL WORLD



Broadcast With The Fidelity Of Direct FM

What makes the listener turn the dial to your FM station? Quality. And quality alone. Programming at such levels virtually demands highest fidelity transmission. To achieve such standards the unquestioned choice of knowledgeable FM stations is RCA's unmatched Direct FM Transmitter. This system is easiest to tune and holds its adjustment best. Whatever the power class, you are assured minimum distortion and wide frequency response. Such performance is

the happy result of RCA's long background of pioneering and achievement in the wonderful world of radio.

RCA designs and builds its complete line of transmitters to accommodate stereophonic signals and an SCA multiplex subchannel. For complete technical details on any of RCA's Direct FM transmitters, see your RCA Broadcast Representative. Or, write: RCA Broadcast and Television Equipment, Dept. DC-22, Building 15-5, Camden, N.J.



The Most Trusted Name in Radio

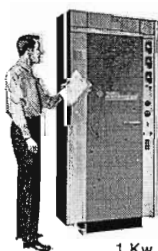

1 Kw

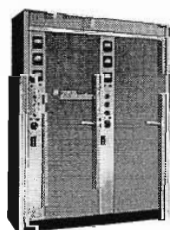

5 Kw

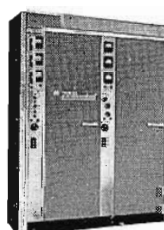

10 Kw

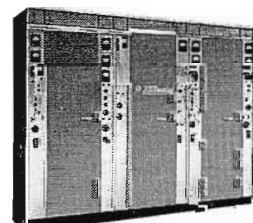

20 Kw

BROADCAST NEWS

*published by***RADIO CORPORATION OF AMERICA**

BROADCAST & COMMUNICATIONS PRODUCTS DIVISION, CAMDEN, N. J.

issued quarterly

PRICE *in U.S.A. - - - - - \$4.00 for 4 issues*
outside U.S.A. - - - \$5.00 for 4 issues

CONTENTS

	Page
NEW GENERATION OF BROADCAST EQUIPMENT	7
REEVES TV TAPE SERVICE CENTER	14
THE ACT OF THEATRE	26
RCA COLOR UNIT IN WBAP-TV STOCK SHOW COVERAGE	33
KSTP CONTINUES PIONEERING TRADITION IN COLOR	34
AIR BEARINGS FOR TV TAPE RECORDERS	58
UNIVERSAL PICKUP CARTRIDGE	60
STEREO RECORDS AND STEREO BROADCASTING	62
USERS REPORT ON TS-40 SWITCHING EQUIPMENT	64
1 KW AM TRANSMITTER WITH SPACE AGE RELIABILITY	68

As We Were Saying

Some things in the broadcast business are not as obvious as they seem. The merits of equipment, for instance. Newcomers to the business have an alarming (from our viewpoint) tendency to think of one transmitter as being just as good as another transmitter. And, worse yet, to think of one company as being just as good as another to do business with.

The men who built this business think differently. They started with crystal sets and 10-watt transmitters. They know how the performance, reliability and efficiency of equipment improved as the industry grew and matured. They know which companies labored long (and sometimes

painfully) to develop the experience on which today's equipment designs are based. They know which companies will, when they have produced a lemon, work on it till they get it right. They know which companies have, over the years, furnished a constant flow of technical bulletins (and modification kits) to enable stations to keep their key equipment up-to-date. They know which companies have 24-hour parts service (and can furnish parts for transmitters made years ago). They know which salesmen they can count on for help in planning, for carefully considered advice on equipment, for service before—and after—installation. The oldtimers know, the newcomers will learn.

Copyright 1962

All Rights Reserved Trademark(s) ®Registered. Marca(s) Registrada(s) Radio Corporation of America, Broadcast & Communications Products Division, Camden, N. J.

PRINTED
IN
U.S.A.

*As We Were
Saying*

MODIFY, IMPROVE, REFINE is a cycle which most of the more complicated items of broadcast equipment go through sooner or later. Few items are born perfect. Most—after a few months of field use—are modified. Moreover, the original design is hardly finished before the engineers set out to improve the performance. And even after many improvements they keep on refining.

It's a procedure which often tries not only your patience, but ours, too. However, it is this never-ending development that produces the truly "great" equipments which become the standards of the industry. Take the TK-11 Camera, for example. In its ten-year history, some 30 modification kits have been made available to users. The improvements incorporated in these modifications have made a good camera into a fine one, a camera that has been the industry standard for ten years. And they have kept it up-to-date—so much so that of over a thousand manufactured all, we believe, are still in use.

Our thirty-five year record for improving, refining and up-dating our products is one which no one else in the broadcast industry can match.

FIVE FOR FIVE is good in any league. In the satellite league it's tops. Just recently the fifth RCA-built TIROS weather satellite was launched into orbit and, like its four predecessors, immediately began sending back remarkably good pictures of cloud formations around the world.

The 286-pound TIROS satellites contain two TV cameras and two small TV tape recorders. Pictures from the cameras are recorded on tape—then played back at slow speed to ground stations. The first four TIROS satellites have sent back more than 126,000 TV weather pictures to date.

TIROS 5 has been launched in an orbit which will enable it to watch the Northern Hemisphere during most of the forthcoming hurricane season. Last Fall, TIROS 3 photographs disclosed Hurricane Esther two days before conventional means could have spotted it. The Weather Bureau is planning to relay hurricane pictures snapped by TIROS 5 as swiftly as possible to warning centers in Miami, New Orleans and San Juan for help in predicting the course of the storms.

The TIROS satellites were designed, and are built, by RCA's Astro-Electronics Division. We like to think that our many years of work on broadcast TV cameras and recording equipment contributed to the astounding success and unusual reliability of these weather satellites.

NOT JUST BECAUSE he is the boss do we applaud the National Academy of Television Arts and Sciences' award of a special "Emmy" to General David Sarnoff. Rather it is because their action—and the words of the citation express the way we

personally feel. It's the way we felt before we worked for RCA (quite awhile ago)—and the way we think we would feel today, even if we didn't work for RCA. The citation read:

"The Trustees of the Television Academy have voted this year to honor an illustrious statesman of our industry. He has been both pioneer and prophet. He has inspired and supported many of television's finest cultural achievements. He has laid many of our cornerstones, blueprinted much of our future and has been the leading architect in the development of color television.

"For his many years of vision and accomplishment—a Trustees' Award to the Chairman of the Board of the Radio Corporation of America, Brigadier General David Sarnoff."

CORNBERG ON THEATRE story (Pg. 26) may seem a little out of place in a magazine devoted to broadcast techniques. But we like it, if for no other reason than the change of pace. Sol Cornberg, who for some years was Director of Studio and Plant Planning for NBC, has done several previous articles for us. (Space Control Production Area, BROADCAST NEWS No. 86, December 1955; Television Seeks Architectural Form, BROADCAST NEWS No. 95, June 1957). What we particularly like about his ideas is the soaring imagination—which is in marked contrast to the mundane material with which we regularly work.

Sol is now the head of his own firm, Sol Cornberg Associates, specialists in the communications arts. While the article on Pg. 26 is perhaps more theatre than television, it may stimulate ideas on use of TV in theatre-type settings. Perhaps we could all benefit by thinking of television more as theatre!

L. L. CAUDLE, JR., Chief Engineer of WSOC-TV, Charlotte, and author of the TS-40 story on Pg. 64, died suddenly on March 17, following a heart attack. Known and loved by all of the old-timers in the industry, "Pappy" Caudle had been a familiar figure at broadcast technical meetings for many years. His passing, just before the NAB Convention, left a noticeable gap in the group of long-time friends who are wont to gather in the RCA suite.

"Pappy" Caudle had been in broadcasting since boyhood. He graduated from RCA Institutes in 1932, joined WSOC the following year, became chief engineer in 1936. He planned and built WSOC AM, FM and TV facilities. The new WSOC-TV plant was his biggest pride and joy—and he never ceased talking about it. The little piece about his TS-40 was written several weeks before he died. Knowing him as we did, we felt that he would want us to go ahead with its publication.



WENR, Chicago, Ill., installation of RCA Type 50A, 50-KW Transmitter, purchased August, 1927.

*As We Were
Saying*

JUST FOR THE RECORD we would like to make a small correction to the information published by an esteemed trade journal on the occasion of radio's recently celebrated 40th (??) anniversary. It's probably not of great importance, but the statement, "RCA began selling station apparatus in 1929," is not quite correct.

We do not know the exact date when the first enterprising RCA salesman rapped on a broadcast station door. It probably was not long after July 7, 1926. And it certainly was sometime before August 20, 1927—because the record shows that on that date WENR, Chicago, signed an RCA contract for an RCA Type 50A (50 KW) Transmitter.

The WENR transmitter was installed during the spring of 1928. Whether it was the first "RCA" broadcast transmitter on the air (in other than an RCA-owned station) is a moot point, for KPRC in Houston took the air about the same time with an RCA 1001-A Transmitter (Serial No. 1) WKY, Oklahoma City, and WJDX, Jackson, Mississippi, followed closely thereafter, also with RCA 1-A Transmitters.

A photograph of the WENR "high-power" installation is shown above. The banks of tubes at the left are "Kenotron" rectifiers. In 1929, these tubes were replaced by RCA-857 mercury vapor rectifiers—and a new power amplifier was installed. (The contract lists it as "RCA 50 KW radio frequency power amplifier utilizing two of the new RCA UV-862 [100 KW] Radiotrons in a balanced amplifier.") This was the fabulous "RCA 50-B" Transmitter which within a short time thereafter was installed by WTIC, WTAM, WHO-WOC, WSM, WCAU, WOAI and others. By 1933, fifteen of the twenty-two high-power (50 KW) stations in the U.S. were using 50-B transmitters. Most of them operated these transmitters through the war years—and, in fact, some have only recently been retired.

Because RCA at the time had no manufacturing facilities the 50A's and 50B's were made partly

by GE and partly by Westinghouse. This was true also of the other RCA transmitters (the 100/250 W, the 1A, B, and C and the 5A and B) sold during the period 1927 to 1933.

In 1930, when RCA set up its own production facilities, many of the GE and Westinghouse engineers who had been working on broadcast transmitters transferred to RCA at Camden, N. J. Together with RCA engineers transferred from New York they formed the nucleus of a new and unique broadcast engineering group. Starting fresh, and untrammled by tradition, or old company policy, they undertook to develop an entirely new line of broadcast equipment.

The first of these new equipments were studio items, including the original 44A Velocity Microphone (The Velocity Microphone, BROADCAST NEWS No. 5, October 1932) and the first "all A-C operated" audio equipments (the 41-B Pre-amplifier and 40-C Line Amplifier). The first transmitter to be wholly designed and produced in Camden was the Type 1-D (1 KW) Transmitter. This transmitter revolutionized the transmitter industry. It was the first of this size to use air-cooled tubes (all previous designs were water-cooled); it was the first to use high-level "Class B" modulation (preceding designs were low-level modulated with a Class B linear as output stage); it was the first of this size to be all A-C operated (previous designs used motor-generators for filament, grid and plate supply); it was the first to have centralized controls and wide front doors providing full accessibility; and it was the first to depart from the old dead-black telephone color and to be "styled" with a feeling for the then-new electronic age.

The 1-D, and succeeding Camden-built transmitters, quickly gave RCA a position of leadership in the broadcast equipment field—a position that it has continued to hold in the nearly 30 years since then.

Well, as we said before, it's not of earth-shaking importance—but it makes us feel better to get the record straight.

NEW TALL TOWER CHAMPS...

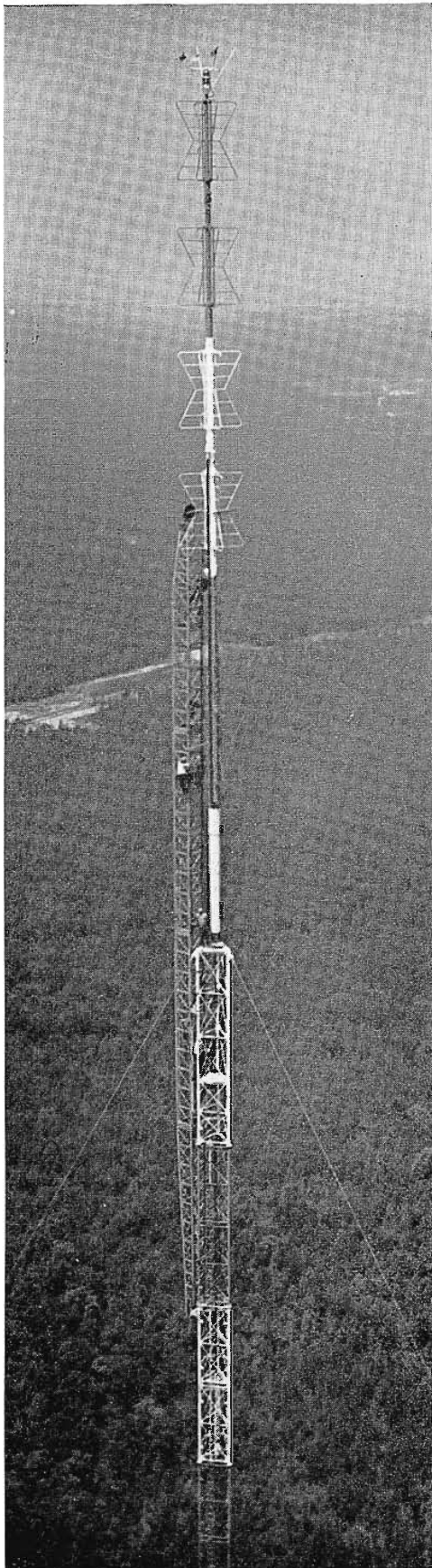

Television antenna tower of stations WRBL-TV and WTVM, Columbus, Georgia, is 1749 feet high—tallest man-made structure in the world.

In the competition for tallest tower honors, broadcasting's equivalent of the space race, stations WTVM and WRBL-TV of Columbus, Ga., are the new joint titleholders. The new champions have pushed their tower to a record height of 1749 feet over the Georgia pine woods, making it "the world's tallest man-made structure."

When first erected in 1960 the two-station tower reached to a mere 1261 feet overall. It was extended in a two-month project that saw a crew of iron-nerved riggers clambering about a gin pole that had been hoisted nearly a third of a mile into the sky.

The antennas—an RCA 6-section Superturnstile and an RCA Mark II Supergain—weighing a total of eleven tons—were stored in the tower base area while 488 feet of tower steel was added to the top of the structure. Then, after additional guys had been fixed, the antennas were replaced,

transmission cables attached and the power switched on.

Thus it was that the two Columbus stations took top honors in broadcasting's sky probes, a title last held by the 1676-foot spire of KFVS-TV, Cape Girardeau, Mo. The RCA project was sub-contracted to Stainless, Inc., tall tower manufacturers, who had designed the original tower for an ultimate maximum height of 1760 feet. Erection work on the extension was by Furr & Edwards Tower Company.

But, even as the first signals were radiated from the augmented tower, it was evident that other broadcasters soon would challenge the Columbus titleholders. Two-thousand-foot towers are under serious consideration. Having far outstripped the Eiffel Tower (984 feet) and the Empire State Building (approx. 1500 feet), the tall tower men appeared headed for a race that to some could end only in a soft landing on the moon.

WOC-TV ORDERS RCA EQUIPMENT FOR NEW STUDIO FACILITY

Station WOC-TV, Davenport, Iowa, has awarded a contract in excess of \$500,000 to the Radio Corporation of America for a full complement of television broadcast equipment to be used in its new studio building now under construction.

The contract covers two TR-22 transistorized color television tape recorders, four TK-12 4½-inch I.O. cameras, color and black-and-white film chains and a complete TS-40 Transistorized Switching system. Dr. David D. Palmer, president, Tri-City Broadcasting Company, owner of WOC-TV, made the announcement recently. He also noted that the facilities

provide for the later addition of four live color TV cameras.

When the 135-by-150 foot building is completed and equipped late this year, WOC-TV will have one of the most modern television studio facilities in the Middle West.

The two-story and basement structure, located on a plot adjacent to the station's present studios at 805 Brady Street, is designed to reflect both the twelve years of WOC-TV's broadcasting experience in Davenport and station management's plans for its future growth and venture into color.

Mr. C. H. Colledge (left) vice-president and general manager RCA Broadcast and Communications Products Division at newest transistorized RCA TV Tape Recorder Type TR-22, with Dr. David D. Palmer, president, Tri-City Broadcasting Company, who has acquired two of these new color recorders for station WOC-TV.

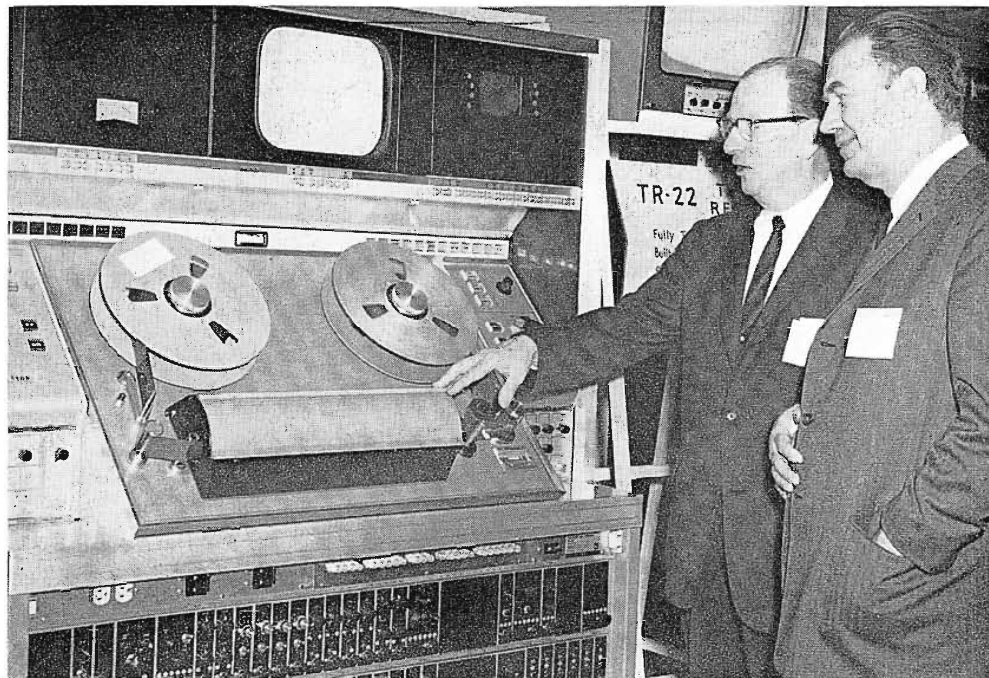

**PALM BEACH
GOES RCA
ALL THE WAY**

Just south of Palm Beach, two new 1049-foot towers now rising into the Florida sky signify the dynamic growth of that resort city's two television broadcasters: WEAT-TV and WPTV. In moving to the new antenna sites, each station has purchased a complete RCA transmitter plant in a general upgrading and modernization of facilities.

By mid-summer, when the tall towers

begin radiating their signals, viewers and advertisers alike in the booming South Florida area will be treated to the best coverage and the most reliable service that quality broadcast equipment can provide. To the Sunshine State, proud home of the astronauts, the technical surge of its two Palm Beach broadcasters adds up to a new electronic penetration of space—this one aimed at the living room screen.

**NEWEST
WEAT-TV
FACILITIES**

Mr. Rex Rand (center) president of Palm Beach TV Co., Inc., owners of WEAT-TV and (right) Mr. Bertram Lebhar, Jr., executive vice-president and general manager. Roy Giles (left) RCA representative in Florida. Equipment shown is newest RCA TV Tape Recorder, Type TR-22. WEAT also ordered a Type TR-11 Compact TV Tape Recorder. Included in the new facilities is RCA's recently introduced 25-kw TV Transmitter, Type TT-25DH, together with transmission line, tower, and a Traveling Wave Antenna with gain of 15. Added film facilities comprise a TK-21 film chain with TP-11 Multiplexer, TP-7 Slide Projector and two TP-6EL Film Projectors. An STL Microwave Link, Type TVM, complete the excellent new equipment package for WEAT-TV.

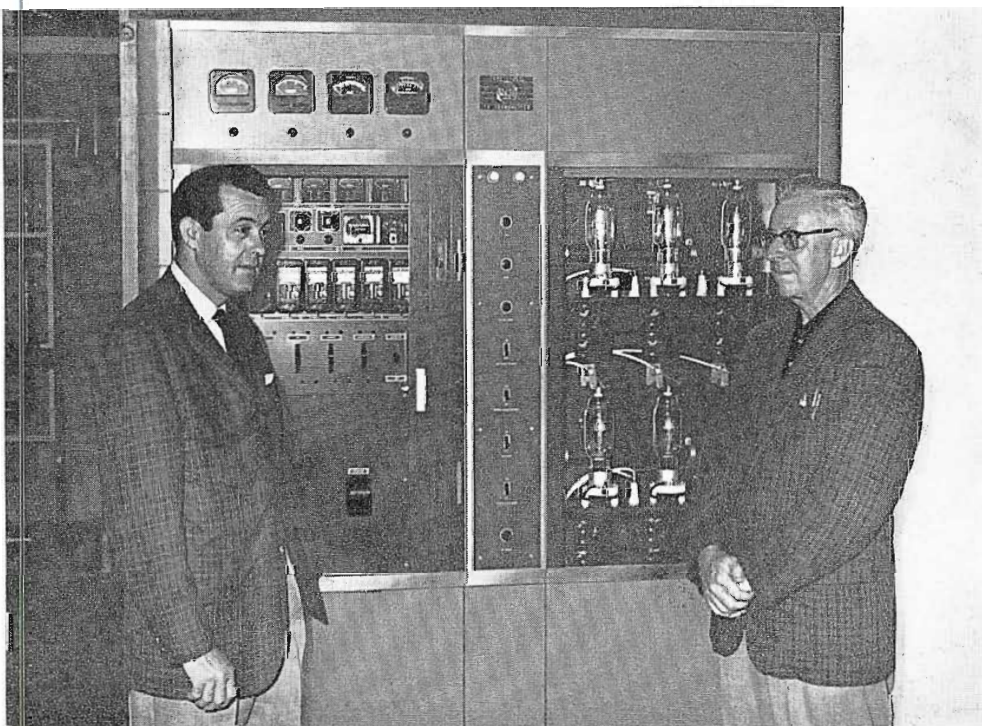

**LATEST
EQUIPMENTS
ACQUIRED BY
WPTV**

Mr. Chester E. Pike, Jr., (left) general manager and Mr. W. Lewis Evenden (right) chief engineer of station WPTV, owned by Scripps-Howard Broadcasting Company. Equipment shown is part of station's new RCA 25-kw Transmitter Type TT-25CL for channel 5 operation. Included in expanded transmitter plant are new transmission line, tower, and Type TF-6B Superturnstile antenna. In expanding its technical facilities WPTV has also ordered two new RCA TV Tape Recorders: a Type TRT-1B Advanced TV Tape Recorder and a Type TR-11, Compact RCA Recorder. These newest additions will make the station one of the finest in equipment facilities.

RCA BROADCAST DIVISION REALIGNS DEPARTMENTS

In order to give more impetus to its drive for new and improved products, and at the same time provide better service to the customers, the RCA Broadcast & Communications Products Division has realigned the departments which handle its broadcast and closed-circuit TV business. The realignment, which was announced on June 1, by Mr. C. H. Colledge, Vice President and General Manager of the Division, creates two new departments: the Broadcast Sales Department, which will be headed by Mr. E. C. Tracy; and the Broadcast Merchandising and Engineering Department under the direction of Mr. A. F. Inglis.

Previous to the new setup Mr. Tracy had been Manager of the Broadcast Equipment Department with responsibility for sales, merchandising and engineering for the broadcast market while Mr. Inglis had been Manager of the CCTV, Film Recording and Scientific Instruments Department with generally similar responsibilities in these areas. However, the equipment requirements for CCTV, Film Recording and Broadcasting had been coming closer and closer together, to the point where the two departments were, in large part, selling identical equipment. Thus some consolidation of the two businesses was indicated.

The new alignment is of the so-called "functional" type. Thus Mr. Inglis will be responsible for the "product" function which includes responsibility for all product planning, for engineering, and for getting the product produced. This is what the text books sometimes refer to as "putting the merchandise on the store

shelf." Similarly, Mr. Tracy will be responsible for the "sales" function. He will concentrate on "selling the merchandise off the store shelf."

Mr. Inglis brings to his new assignment an impressive background in broadcast equipment planning and engineering. Before joining RCA he was a partner in the consulting firm of McIntosh and Inglis in Washington, D.C., and his work as a consultant included close and detailed work with many AM and TV stations. He came to RCA in 1953, as Manager of Broadcast Studio Equipment Planning. In 1955, he became Manager of TV Systems Engineering and in 1958, was appointed Manager, Closed-Circuit TV Department. Later he was also given responsibility for the film recording and scientific equipment businesses.

Mr. Inglis' new organization will include W. B. (Walt) Varnum, who continues as manager of studio equipment merchandising and E. N. (Noel) Luddy, who continues as manager of transmitting equipment merchandising. Walt and Noel will have with them the same groups of product specialists as before—and the advice, assistance and support of these highly competent and experienced people will be available to broadcasters exactly as in the past. Also reporting to Mr. Inglis will be J. E. Young, who continues as manager of transmitting engineering, and A. H. Lind, who moves up to manager of studio, recording and scientific engineering. Also A. M. Miller, manager of the Division's Film Recording and West Coast Operations; F. J. Herrmann, manager of scien-

tific instruments merchandising; and R. H. Edmondson, manager, automation program coordination.

Mr. Tracy, too, is admirably fitted by talent and experience for his new and enlarged sales assignment. With RCA for nearly a quarter of a century, he has been in broadcast equipment sales for the past seventeen years. He joined RCA in 1939—just in time to work on RCA's TV installation at the World's Fair. After war-time service on military electronic gear he was assigned to broadcast sales in the Chicago area in 1945. In 1950, he was named field sales manager, and three years later, sales manager of broadcast equipment. In 1956, he was appointed Manager, Broadcast and TV Department.

In his new assignment Mr. Tracy will have in his department the broadcast station sales group under Dana Pratt (assisted as before by Ed Hill and Dick Newman). He will also have a CC-TV and Scientific Instruments Sales group headed by Paul Bergquist (assisted by Neal Vander Dussen and Warren Charles). Also a new activity, Sales Support and Service, managed by John Cassidy.

Broadcasters will note that the new organization retains all of the old broadcast hands, and adds to their efforts the talents of Andy Inglis, John Cassidy and others who for the past two years have been concentrating in other areas. Further, by assigning managers to functions where their talents and experience will be most useful it should further promote RCA's efforts in the broadcast equipment field.

E. C. Tracy
Manager, Broadcast Sales Department



C. H. Colledge
Division Vice President and General Manager
Broadcast and Communications Products Division

A. F. Inglis
Manager, Broadcast Merchandising and
Engineering Department



NEW GENERATION OF BROADCAST EQUIPMENT INTRODUCED AT NAB CONVENTION

Sharing "star billing" in the RCA exhibit at the recent NAB convention were seven "new generation" broadcast equipments.

The new generation lineup included: an experimental "M-Channel" color camera, TK-42X . . . a 4½-inch I.O. monochrome camera, TK-12 . . . a SIMCON (SIMplified CONtrol) television switching system, TS-100 . . . transistorized tv tape recorder, TR-22 . . . a high-resolution tv film recorder, TFR-1 . . . and matched stereo equipment including dual-channel audio consolette, BC-7 and professional audio tape recorder, RT-21.

In concept, in circuitry, in components, in construction and styling, these equipments mark a radical break from previous designs—and from the old practice in which new designs were largely modifications of preceding types.

New Look

Visitors to the RCA booth were greeted by a new look in both equipment and exhibit. Steel-blue, silver-sheathed space-age styling pervaded the new equipments which were set in a background of crisp white. The spacious white theme was carried throughout the exhibit—right down to the white vinyl "Tessera Corlon" flooring supplied by the Armstrong Cork Company.* The effect was that of the well-equipped tv station of the future.

In appearance, the new generation equipments have much in common. They are distinguished by clean, cool lines, functional flair, and relative compactness.

New Design

In circuits and components the new generation equipments feature many advances. Use of transistors and nuvistors

lead to compactness, high reliability and low maintenance cost. Stabilized circuits reduce warm-up time, eliminate drifting, provide simplified operations.

A New Line

The "new generation" equipments—which are further described on following pages—are the beginning of a new line of broadcast equipment—designed for remote control and automated operation, and built to give convenient operation, easy access to components and extreme ruggedness.

* Tessera comes in 20 color styles—is ideal for heavy traffic commercial interiors, either on-grade or below-grade. It has a .090-inch overall gauge with a .058-inch wearing surface—with wear characteristics equal to Battleship Linoleum. For further data write: Armstrong Cork Co., Lancaster, Pa., attention, Mr. Clyde Hess.

FIG. 1. One of the first sights to greet visitors to the RCA exhibit was the operating live TV studio and an introduction to a new generation in broadcast equipment.



M-CHANNEL COLOR CAMERA



FIG. 2. TK-42X experimental M-Channel color camera. The new camera uses four tubes to produce richer hues in color pictures and for sharper black and white pictures. A single zoom lens replaces the familiar multi-lens turret.

Live Studio

In the live studio area, RCA's experimental color camera, TK-42X, introduced a new concept in color broadcasting, the forerunner of camera equipment for tomorrow's color tv stations. This M-channel design adds a monochrome channel to the red, green, and blue color channels found in present day color cameras. As in four-color printing, the addition of black is designed to improve color detail and registration. It also provides sparkling black-and-white pictures in color transmission.

The TK-42X, shown at the convention, incorporated many unique features and was displayed in order to get broadcaster reaction to these advanced new techniques. When the comments and suggestions of broadcasters are all received and digested, RCA plans to develop a color camera which will truly reflect the needs of color television for the future.

Four pickup tubes are used in the TK-42X Color Camera. Three 1-inch Vidicons

are used for the red, green and blue channels, and a 4½-inch Image Orthicon is used for the monochrome, or M-channel. A built-in zoom lens has been incorporated in the design. Use of this single lens of variable focal length assists in preserving uniform color balance, reduces dollying and facilitates remote control operation. Another advance is the incorporation of stabilized circuitry to permit simplified operation and provide uniform picture quality.

TK-41C Color Camera

Also on display was the Type TK-41C Color TV Camera, which is the standard of the industry. This third generation model of the first practical color studio camera is available for stations desiring to take advantage of the big push to color.

Now embodied in the TK-41C are precision yokes assuring accurate image registration, and new color optics (prisms instead of flat plates) which eliminate spurious reflections in the received picture. Significant improvement in electrical sta-

bility of amplifiers and I.O. control circuits have been incorporated into the TK-41C. These eliminate much of the daily setup routine and reduce the warmup period formerly required.

4½-Inch I.O. Monochrome Camera

Monochrome pictures as recorded by the various tape and film recording equipments were provided by two TK-12 monochrome cameras operating in the studio. These new generation cameras were particularly effective in this use, since their inherent fine picture detail, superb grey-scale rendition and freedom from halo effects assure better tape recordings.

Featured in the TK-12 are stabilized circuits which compensate for changes in temperature, line voltage, and aging. Circuits warm up quickly; pictures are ready for use within minutes after the camera is turned on.

Unique engineering features include an 8-inch viewfinder providing a much larger and brighter picture (200 ft. lamberts). Special effects can be seen on the viewfinder, permitting the cameraman to adjust the camera position to best advantage. Remote iris control permits adjusting all lenses simultaneously. Many other features make the TK-12 extremely easy to operate—the source of finest pictures available.



FIG. 3. TK-41C color TV camera, standard of the industry. New features for 1962 include stabilized circuits for simplified operation, precision yokes for precise registration, and prism optics for sharp clear color pictures.

TS-100 SWITCHING SYSTEM WITH "SIMCON"

RCA's newest tool for simplifying complex television switching operations—the TS-100 Switching System as designed for WBZ-TV, Boston—was shown in simulated operation. The system features "SIMCON" (SIMplified CONtrol) which represents a new concept in pre-set switching for either manual or automated operation.

From the TS-100 a number of basic systems can be custom built to individual broadcasters needs. In the basic systems there is just one button for each picture source. The buttons are back-lighted and show red when the source is "on-air", and green when it is preset. The same buttons are used to setup the next source—whether the transition is to be a "cut", a "lap" or a "wipe". If desired these buttons can be used to control associated mechanical equipment—start and stop tv tape recorders, film slide projectors, etc.

FIG. 4. TS-100 Switching System. The custom console displayed was designed for WBZ-TV in Boston. This represents a new concept in pre-set switching for manual or automated operation.

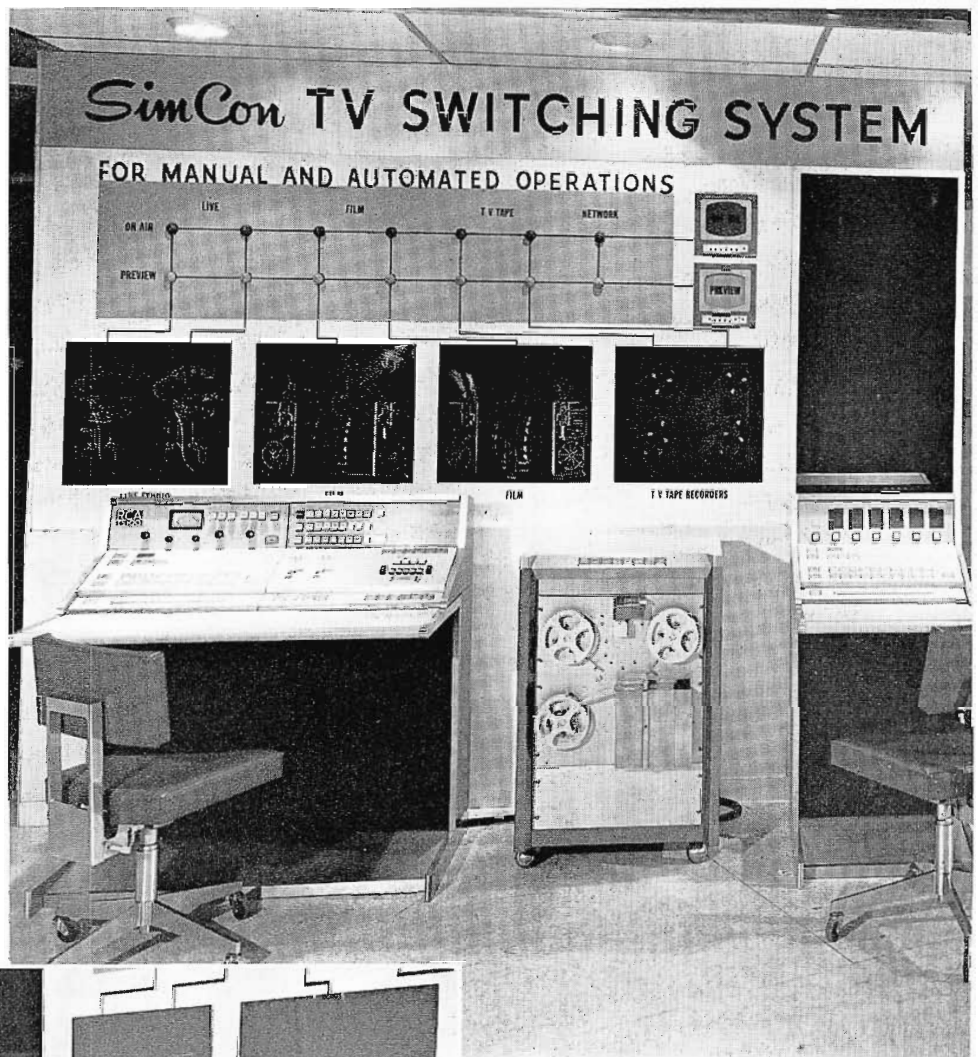

FIG. 5. TV's new control console handles all the station's switching operations, controls associated mechanical equipment, and can be completely automated by adding clock and memory units.



With the addition of other simplified controls, the basic switcher can also perform audio switching and provide special effects, as may be required. Operation can be completely automated with the addition of clock and memory units.

The great flexibility in the modular design of the system components and operational features permit TS-100 systems to be assembled to fit the most complicated requirements of the largest station or the normal requirements of any station. TS-100 Systems reduce the complexity of the operating position, lessen the danger of switching errors, provide possible operating economies and make feasible any degree of automaticity desired.

TRANSISTORIZED TV TAPE RECORDER



FIG. 6. TR-22 Transistorized TV Tape Console features all the latest TV tape advancements. Includes air bearing headwheel, Pix-lock, carrier and deviation monitors—provision for color and ATC modules.

Complete Line of TV Tape Equipment

A wide choice of tv tape equipment was displayed in operation—including the TR-22 transistorized, TRT-1B standard and TR-11 compact tape recorders. This expanded product line points up two well defined trends among tv tape users: toward exploiting the full capability of tape quality, and toward economy and broader use of tape for broadcast purposes.

Transistorized TV Tape

The TR-22 fully-transistorized TV Tape Recorder embodies the newest advances in the state of the tape recording art, all incorporated in one compact console. No external racks are necessary—all recording, monitoring and testing facilities are in a single compact unit. Operation is simplified. Valuable floor space is conserved.

All the latest RCA tv tape advances are included. Air bearing headwheel operation . . . Pix-lock system for special effects

. . . carrier and deviation monitor are built in. Also, provision has been made for the addition of color and automatic timing correction modules—all within the single compact console.

The TR-22 is the tv tape recorder made to capture and faithfully reproduce the finest quality pictures that new generation tv cameras will provide. This kind of top performance can be achieved and duplicated day after day, without constant technical supervision. For finest quality original tapes—master tapes from which excellent tape or film copies can be made—the TR-22 stands alone.

Compact TV Tape with Dual Speed

To demonstrate economies recently made possible in tape operations, the TR-11 Compact Recorder was operated with a dual speed accessory. Available for all RCA recorders, this new engineering advance combines all the benefits of standard quadruplex recording with the savings of

half-speed operation. It permits tape speed to be switchable from conventional 15 inches per second to half speed of $7\frac{1}{2}$ ips. At the slower speed, double the amount of information is recorded on a given amount of tape. This effects a 50 per cent saving in tape costs and storage space.

TV Tape Mobile Unit

Also displayed was a new TV Tape Mobile Unit, TJ-11—priced at less than \$50,000. The unit uses a Metro Van body to accommodate a short rack version of the TR-11 Recorder. In this model four short racks house all the facilities of the standard three-rack recorder. Two groupings of two racks each are installed on either side of vehicle. The racks are installed on metal tracks to facilitate servicing and to permit removal of the entire recorder for studio use, if desired. The TJ-11 mobile unit is completely equipped with recorder, storage and work cabinets, and an air-conditioning and heating system.

TELEVISION FILM RECORDER

Television pictures recorded on film and played back in less than two minutes highlighted the film recording demonstration. This feat was accomplished using a new generation Television Film Recorder, TFR-1, in conjunction with an Eastman Viscomat hot processor, TP-6 projector and TK-21 Vidicon Film Camera Chain. Put to the severest of tests—comparing live input to film output on adjacent monitors—the TFR-1 produced pictures of consistently fine quality.

Using a completely different approach to producing high quality film recordings, this new recorder eliminates the shutter bar problem and, produces high-resolution pictures with consistently fine results. Design of a high resolution Kinescope, self-adjusting circuits and a double aperture film camera—all enter into the creation of the TFR-1.

The new Kinescope is capable of resolving at least 800 lines at the center of the raster and at least 600 lines in the corners. It provides a highlight brightness in excess of 160 foot lamberts. It can produce sufficient highlight brightness to permit operation of the camera at reasonable F stops. It is also capable of producing “blacks” immediately adjacent to “white” areas. “Dynamic Beam Focusing”—the mixture of several focusing waveforms—is employed to maintain minimum spot size. The result is more uniform focus.

Reproduction of detail by the display tube is enhanced by reducing dispersion, halation, and blooming. Since exposure is precisely controlled, an optimum transfer characteristic is achieved. The slow-speed camera virtually eliminates vibration. Use of a double aperture eliminates the so-called shutter bar. This excellence of pic-

ture quality is reproducible in day to day operation—without need for specially trained personnel or unusual procedures.

Other new features include a completely automatic method of exposure control based on comparison to a calibrated standard. Desired contrast is selected by means of calibrated filters.

Controls have been simplified—the two main operating controls are pedestal and gain. Each operation is fully instrumented. A multimeter is included for reading significant voltages throughout the equipment. A built-in waveform monitor has pushbutton inputs for monitoring important functions. A signal light system indicates proper operation—warns of possible circuit misadjustments. These facilities make it easy for the operator to get and maintain a consistently high standard of film reproduction.

FIG. 7. Television film recording demonstration. TV pictures were recorded on film and played back through a TV film system in less than two minutes. Left to right are TFR-1 film recorder, Eastman Viscomat hot processor, and TP-6 projector with TK-21 Vidicon film camera.



MATCHED STEREO EQUIPMENT



FIG. 8. Matched FM stereo equipment including (left to right) BQ-2C Turntable with Universal Pickup Cartridge, BC-7 Stereo Console and RT-21 Stereo Tape Recorder. In foreground is RCA's transistorized cartridge tape system.

A model FM stereo station, with complete studio and transmitting equipment was featured. The equipment represented the RCA "matched system concept" in which individual units are engineered to complement each other, assuring highest quality results. Several new equipments were featured in operation.

Stereo Console

A new Dual-Channel Console, BC-7, provided complete stereo or monophonic mixing, switching monitoring and cue/talkback. All transistor design of this unit features plug-in amplifiers for ease of servicing. When used for stereo operation, the master and monitor gain controls are ganged together for simplified operation. Smooth action, dual mixing controls are used in all stereo mixing positions. Five positions are available for stereo; ten for monaural use.

Stereo Tape Recorder

The new RT-21 Professional Tape Recorder is ideally suited to stereo or monaural operations. The recorder is completely transistorized and accommodates two module amplifiers for stereo applica-

tions. Easy speed change, simplified threading and variable cuing speed are only a few of the advanced performance features of the RT-21. Constant torque motors are used to assure uniform speed, and mechanical braking operates immediately in the event of power loss to prevent tape damage. Sapphire tape lifters and guides reduce wear and permit smooth tape movement.

Universal Pickup Cartridge

Shown for the first time was a new Universal Pickup Cartridge for both stereo and monaural operations. In this new design, easy replacement of plug-in styli eliminates the need for costly and time consuming factory repairs. Also stereo or monaural operation is determined by external electrical connections to the cartridge. The cartridge fits standard RCA 12-inch and 16-inch tone arms.

Stereo Transmitting Equipment

Two FM transmitters were highlighted in the exhibit—the BTF-1D and BTF-10D. Both feature the RCA "Direct FM" exciter and silicon power supplies. The complete line of FM transmitters are designed to accommodate stereo signals and an SCA multiplex sub-channel.

Other equipments shown included the BTS-1A Stereo Subcarrier Generator, BTX-1A Subcarrier Generator, and BW-73 FM Multiplex Monitor.



FIG. 9. RT-21 Stereo Tape Recorder in new console mounting gives top quality stereo performance. Also includes special stereo features such as module amplifiers and provision for extra stereo playback head.

RADIO AND TELEVISION TRANSMITTING EQUIPMENT

Recent additions to RCA's complete line of radio and television transmitters were on display. These included 1 and 5 kw AM transmitters and two 25 kw's, one for UHF and one for VHF television.

25 KW VHF TV Transmitter

Newest RCA tv transmitter is the TT-25DH. The transmitter includes latest design features—completely siliconized power supplies and high efficiency air cooled tubes such as the 6166-A for long life and reliability. Single ended r-f circuits greatly reduce the number of necessary tubes and circuit components. Complete overload protection and indicating lights aid in quick location of faulty circuits. Inter-carrier frequency control accurately maintains frequency separation between aural and visual carriers.

Modern mechanical design reduces space requirements as much as 50 per cent over previous designs. This reduction is made possible by the walk-in enclosure design of the TT-25DH and allows for installation in existing buildings. Walk-in

construction also eliminates the need for external access space at the rear of the transmitter enclosure. The enclosure may be placed directly against a wall or in a corner of the room if an air intake opening is provided. Access to all components is possible from within.

High Efficiency AM Transmitters

Two of the latest design AM transmitters were on display—the BTA-1R1 and BTA-5T. Both feature high efficiency circuits, siliconized power supplies and temperature controlled crystal ovens.

The BTA-1R1 is designed to provide improved performance, single control tuning, simplified installation, and low cost performance. Modern trends in AM radio broadcasting including remote control and Conelrad requirements together with all-round economy and dependability are also featured in the BT-1R1.

The transmitter easily fits into operations where power reduction at night is required. For "day-night" operation the transmitter incorporates a built-in power

cutback system. By pressing a switch on the front or at a remote panel, the transmitter can be cut back in power to either 500 or 250 watts.

The BTA-5T is an air-cooled transmitter featuring a number of design developments, including an important development in Class C amplifier design. The new high-efficiency power amplifier permits one long-life 5762 tube to deliver the nominal 5 kw with 5.5 kw power output capability. The plate efficiency exceeds that of a conventional class C amplifier by an average 15 per cent. As a result, considerable power savings can be realized.

Other new design techniques of the BTA-5T provide simplified tuning, increased safety, longer tube life and improved performance. After initial adjustments, the transmitter can be tuned from the front panel. This is accomplished by only two controls. Provisions for manual or remote control operation are incorporated in the transmitter. For safety, all doors and panels are interlocked and grounding switches protect operating personnel.

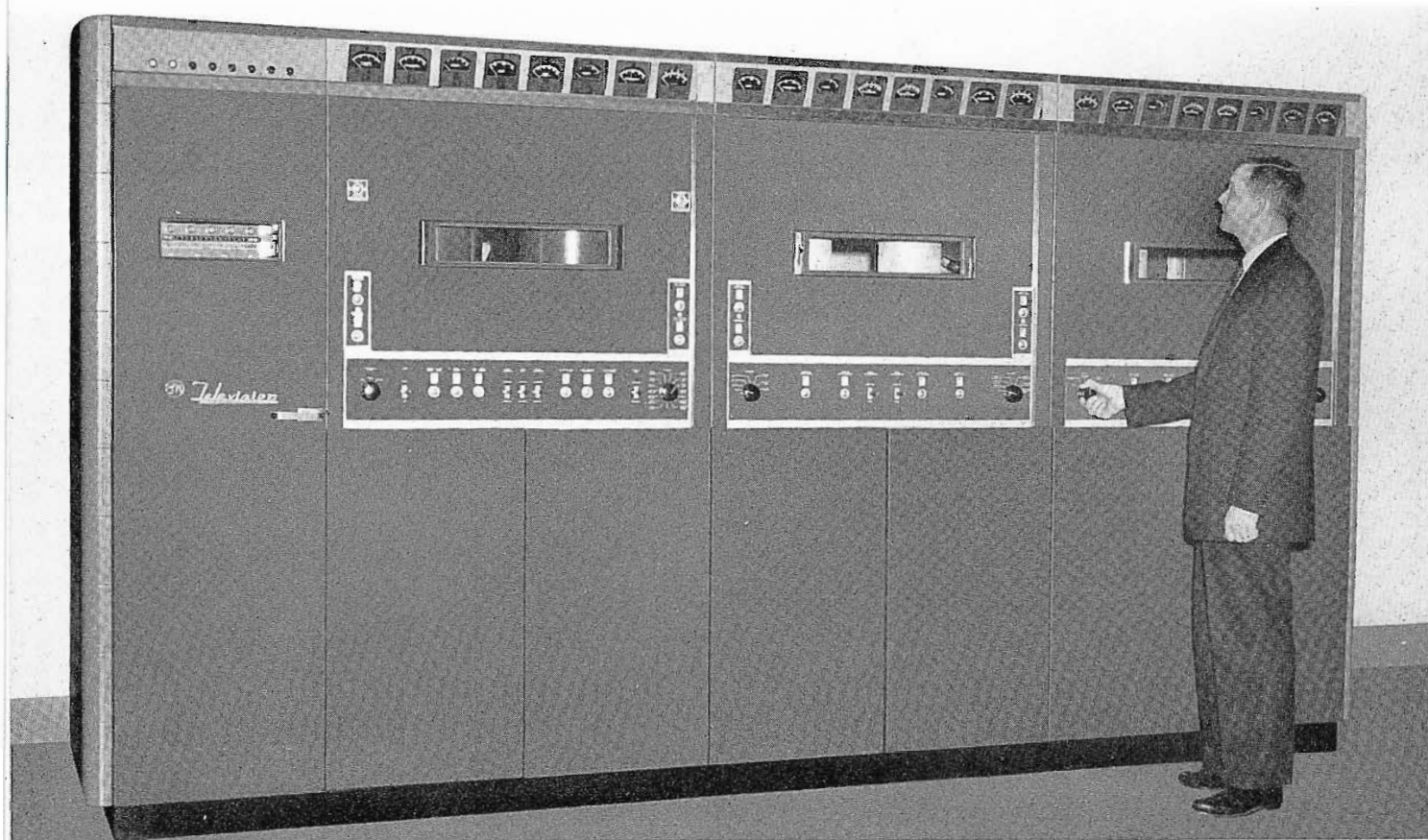
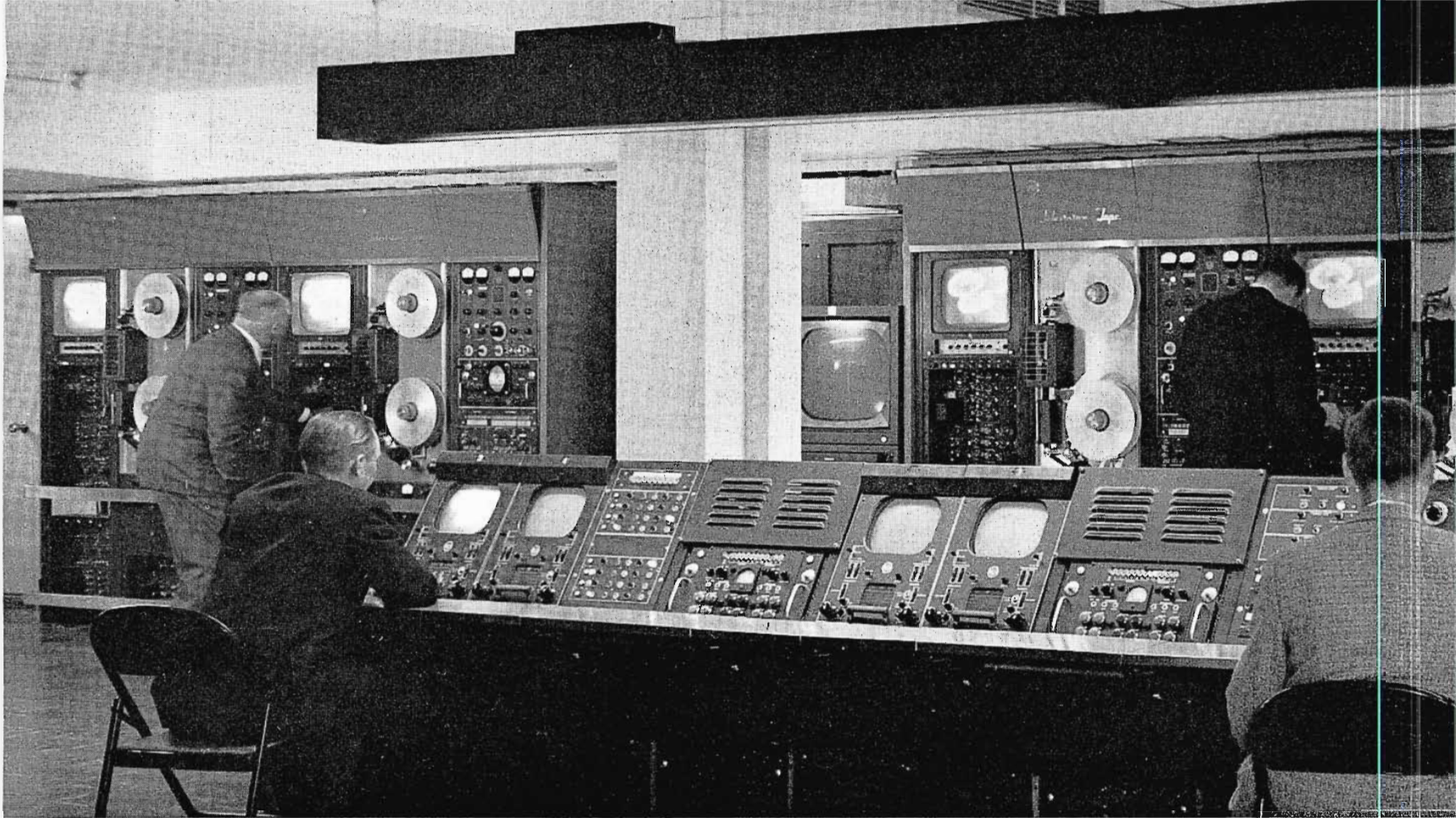

FIG. 10. Newest RCA TV transmitter, the TT-25DH. Modern mechanical design reduces space requirements as much as 50 per cent over previous designs.



REEVES TELEVISION TAPE SERVICE CENTER

Employs 8 RCA Recorders, 2 Film Systems, TS-40 Switching and Effects to Offer Complete Recording, Playback, Mixing and Dubbing Services to Advertisers and Agencies, Broadcasters and Producers of Programs and Commercials

by ROBERT BYLOFF
*Manager TV Tape Recording,
 Reeves Sound Studios, New York City*

Reeves Sound Studios located at 304 East 44th Street in New York City, one block from the United Nations, has the most complete specialized television tape installation in the world. Here are housed RCA color and monochrome tv tape recorders, mixing rooms, film and live camera chains, and audio facilities all directed toward the goal of providing the most professional and highest quality video tape transfer, copying, and mixing services available anywhere. As such the Reeves Studios act as a service organization to the entire television industry.

Sound Recording

Reeves Sound Studios was founded in 1933 by Hazard E. Reeves, a pioneer in sound recording. Mr. Reeves also founded

Reeves-Ely Laboratories, Inc., which now represents a substantial part of the companies comprising Dynamics Corporation of America, Cinerama, Inc., Audio Devices, Inc. and Reeves Soundcraft Corp., a manufacturer of recording tape and discs.

Reeves Studios grew to be the largest independent sound studio in the world. Its sound business consists mainly of sound recording and mixing for motion pictures. In this process the many recorded sound tracks for a picture which would include dialogue, music, and effects are threaded up on sound "dubbers" and run interlocked with the picture. The sound mixer then controls the intensity and quality of each of the tracks through his mixing console and the mixed track is recorded.

TV Tape Recording

In 1959 Mr. Reeves and Mr. Chester L. Stewart, the operating head of the studio, thought it was time to introduce these same techniques used for so long in motion pictures to the video tape field. They contracted with RCA for the largest single purchase of television tape equipment and associated apparatus up till that time. The plan was to produce finished master programs through the "mixing" of scenes edited onto several rolls of video tape and played and re-recorded simultaneously through a mixing console. Thus, dissolves and effects transitions and super-impositions could be used between tapes. At that time the copying of video tape was only experimental and the precision servos and

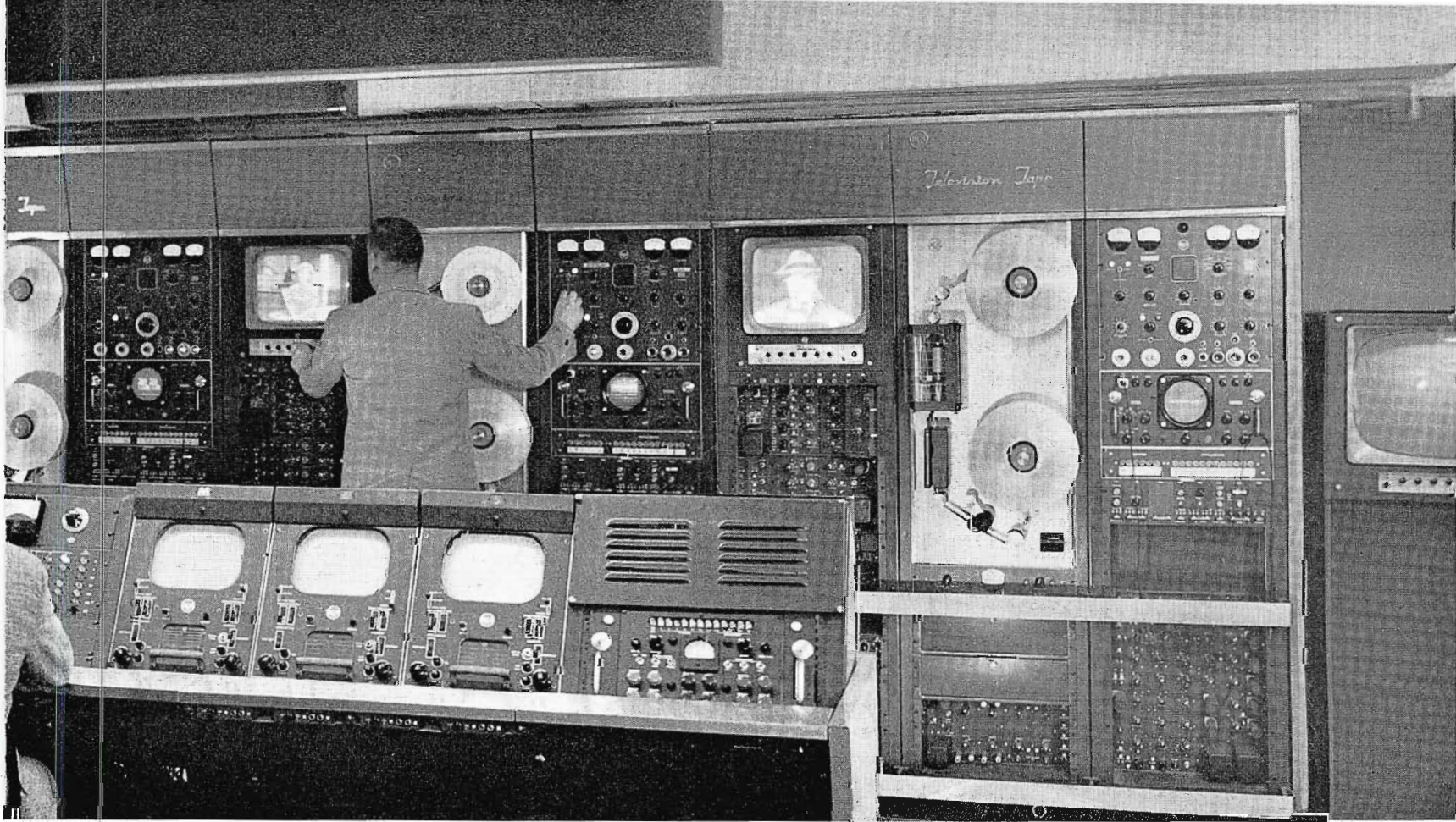

FIG. 1. Main Recording Room. This view shows six of the RCA television tape recorders and the camera control console.

electronic time correction equipment, such as Pix-lock and A.T.C., necessary to satisfactorily dissolve between tapes was not yet available. However, RCA demonstrated satisfactory tape copies and showed the work they were doing to permit mixing techniques to be employed, and the decision was made to go ahead.



FIG. 2. Chester L. Stewart, President of Reeves Sound Studios.

Equipment Installation

The major equipment items are as follows:

- 8—RCA TRT-1A television tape recorders
- 2—Color racks for tape recorders
- 2—TK-21 film chains
- 2—TK-26 color film chains
- 2—TP-35 35 mm projectors
- 2—TP-6C 16mm projectors
- 1—TP-7 slide projector
- 1—TK-11 live camera chain
- 1—TK-41 color live camera chain
- 3—TS-40 switching systems
- 2—GPL kinescope recorders
- 1—RCA 16mm film recorder
- 1—Filmline 16mm film processor
- 1—Bell & Howell film printer
- 3—Fairchild audio tape recorders

In addition to these major items there are synchronizing generators, distribution amplifiers, and monitors. These equipments are arranged in 9 major areas. These areas are the main recording room, telecine, 2 mixing rooms, kinescope recording room, equipment room, printing room, sound transfer room, and laboratory.

Main Recording Room

The eight tape recorders, camera con-

rol console, and transmission racks are located in the main recording room. The tape machines were arranged in an in-line arrangement to make for best operating efficiency for mixing service. Two of the machines are colorized, but the arrangement was made to permit colorizing of all the equipment at some later date. Special color racks were built to house the color processing chassis and the color monitor for each machine.

A TS-40 switcher was installed with push button panels at each machine and also at a central point in the camera control console set-up. The switcher may be used to select audio and video input signals to the recorders or to switch signals from the recorders to any remote point.

When a machine is being used to feed a picture to a studio, the operator may switch from a test pattern or black signal to the machine output after the machine has stabilized, thus during rewind operations the remote point is not troubled by tape noise and "Donald Duck" audio. The transmission tracks contain the audio and video jack fields, monitoring facilities, test signal generators, colorplexers, distribution amplifiers, and remote control patching for tape machines and projectors. Any or all machines can be remotely controlled from either mixing room, any studio in the building or from the camera control console.

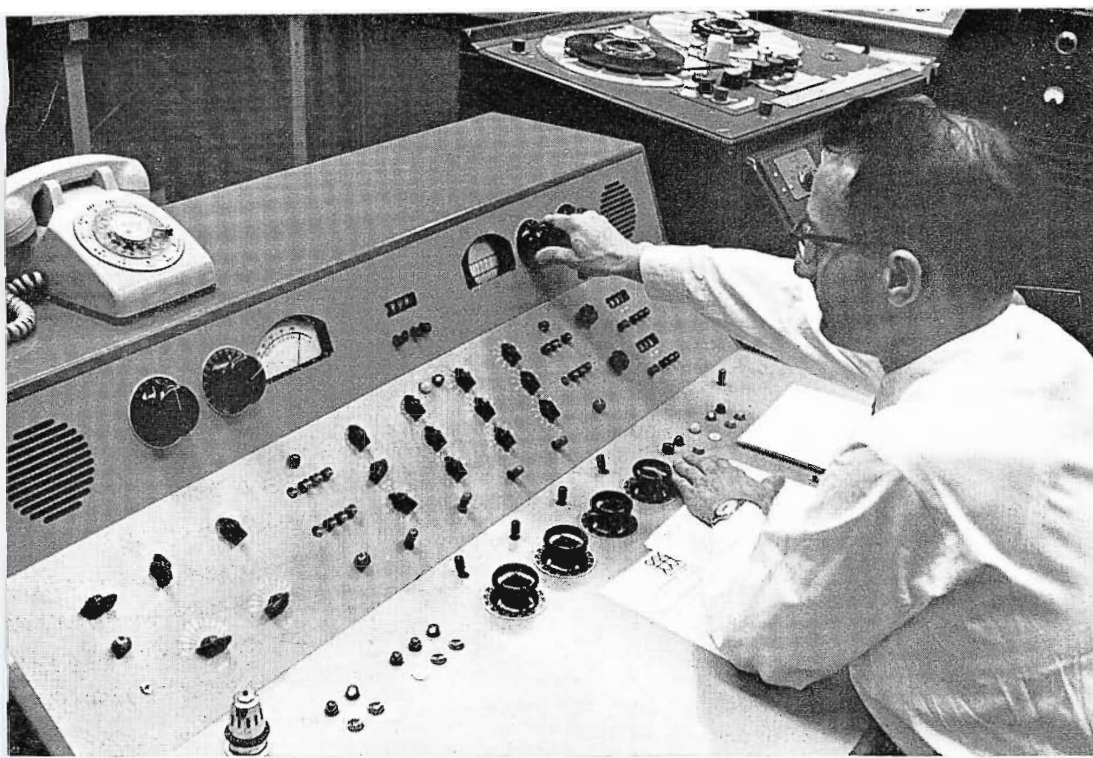

FIG. 3. Sound Transfer Console. All sound tracks going to film are equalized through this console.

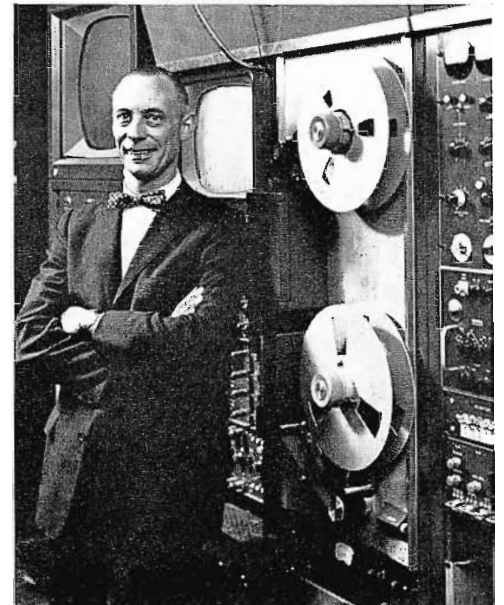

FIG. 4. The author of this article at one of the color RCA television tape recorders.

Master Control

The camera control console, which is also a master switching and control position consists of the camera control positions for the two black and white and the two color film chains as well as the camera controls for the live color and black and white cameras. Two additional console housings contain remote sync generator changeover switches, remote control push buttons for tape and film, the master switcher controls associated with the tape machines. Also contained are: stabilizing amplifier remote controls, and an extensive monitoring switcher, which allows the operator to monitor all inputs to tape machines

and the outputs of all picture sources in the plant.

Telecine Facilities

The telecine room contains two TP-15 multiplex arrangements each with a 16mm and 35mm projector, a slide projector and monochrome and color film chains. Each of the projectors are equipped with interlock selsyns to permit their interlocked operation with sound dubbers in the sound studios.

Mixing Rooms

Two identical mixing rooms are used for starting and stopping all equipment in the plant, and for monitoring and switching of picture and sound sources to make composite mixes of programs. Each contains a TS-40 switcher with special effects and dissolve facility, an 18 input audio mixing console with equalization available in every

channel, picture source monitors on all video inputs, preview and program monitors, a footage clock, and an audio tape recorder. The video console also has remote stabilizing amplifier controls and remote controls for operating tape machines and projectors.

Some special controls permit the viewing and hearing of programs with limited bandwidth as would be seen and heard over an ordinary television receiver, master start buttons for simultaneously starting all equipment associated with the particular job, and footage clock resets.

The picture sources available to each mixing room are 8 tape machines, the 4 film chains, and the 2 live chains. The sound sources available are the same as the picture sources plus the outputs of 40 sound dubbers which use 16mm or 35mm sprocketed magnetic film or optical sound



FIG. 5. Front entrance of Reeves Studios on East 44th Street in New York City.

FIG. 6. Reeves is equipped with two RCA color television tape recorders. The other six RCA recorders handle monochrome only but may be converted to color at any time.

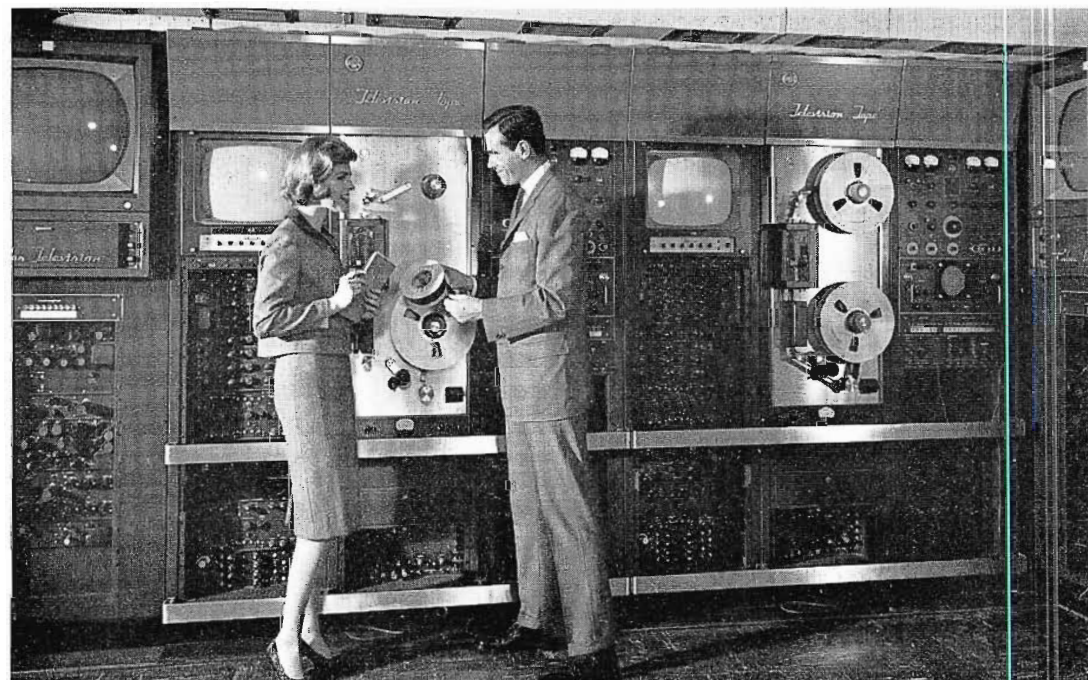

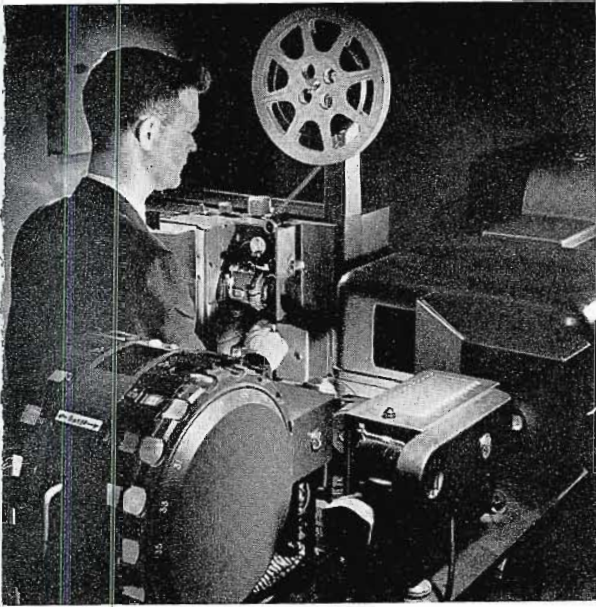

FIG. 7. Ken Foster threading 16mm TV film projector in Telecine room.

tracks. All of the equipment in the studio is so interlocked that it comes up to speed and down to a stop in positive synchronization so that complete frame-by-frame control of all sound and picture elements is maintained.

Kinescope Recording

This area contains the kinescope recorders, and a 1/4-inch Fairchild sound recorder. A specially built photometer is used to guarantee accurate exposure of the film. Sound is recorded on the 1/4-inch "pic-sync" audio recorder and later transferred to optical film in the studio's sound transfer room where proper audio monitoring is available to allow proper choice of equalization of the sound.

Equipment Room

The equipment room contains the sync generators, pulse distribution, TS-40

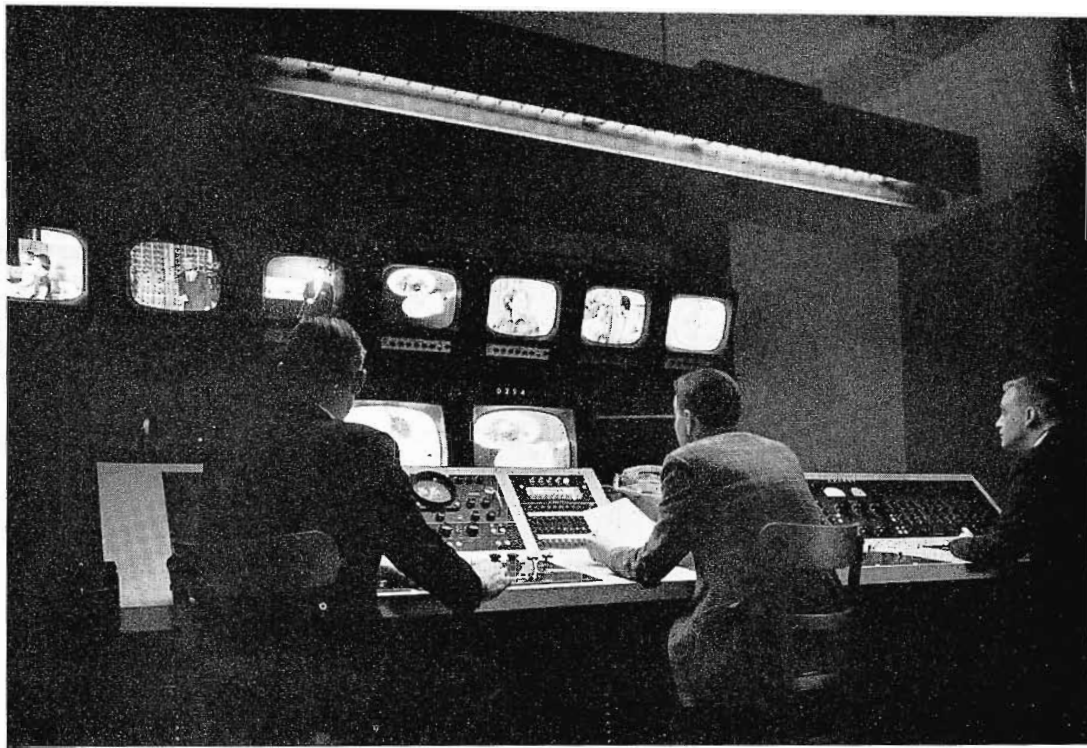

FIG. 8. Studio X—one of two mixing rooms showing input, preview and program monitors. The left side of the console is for video control, the right side for audio control. There are 9 video inputs, 18 audio channels. Dissolves and 150 RCA effects can be made here.

switchers, audio amplifiers, and power supplies. In addition it contains the maintenance shop.

Printing Room

The printing room contains a Bell and Howell printer for printing picture and sound kinescope negatives on the final print stock. This room as well as the kinescope recording room are humidified to the proper environmental conditions for best film handling. (Of course the entire plant is also air conditioned.)

Sound Transfer

This room contains all sorts of audio playback machines (1/4-inch tape, 35mm and 16mm magnetic and optical, and disc turntables) and an audio console and speaker to permit the playback of recordings, the proper equalization of them, and

the transfer of that sound to optical sound tracks, either 16 or 35mm. For kinescope recordings, the sound is transferred to 16mm film.

The Laboratory

The laboratory was installed primarily to allow Reeves to have complete control over the process. Only by having complete control can consistently good results be achieved either in sound recording or kinescope recording. Delivery of product on schedule can be controlled also. The laboratory contains a sound processing machine which will handle either 35 or 16mm sound track, a Filmline processor with both positive and negative tanks for handling either 16mm negative or print stock, a Harnfeld sensitometer, and a densitometer. These last two equipments are essential for controlling quality of the ultimate laboratory product.

FIG. 9. The camera switching and central control position in the main recording room. From this position all equipments can be started and stopped, monitored and switched.



FIG. 10. Central control position of main console. Here all equipments can be put into the record mode, monitored and switched.





FIG. 11. Reeves kinescope recorder. Ken Jordan, kine operator. A second unit is being installed.

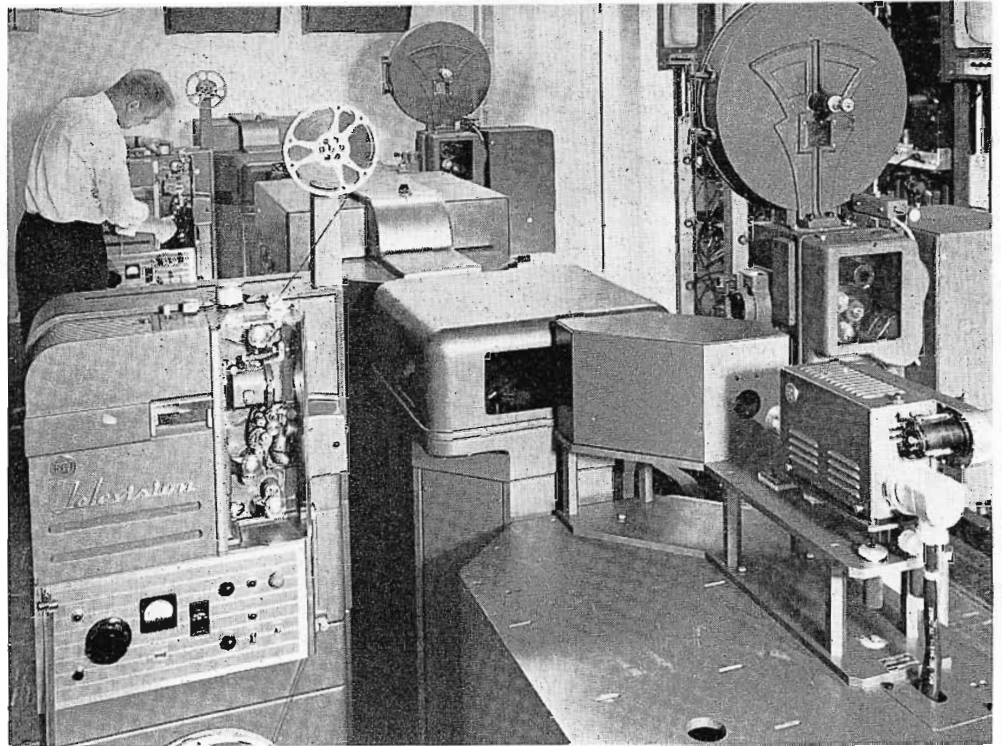

FIG. 12. Telecine room equipped with two TP-15 multiplexer nests with TK-21, TK-26 Film Cameras and TP-35, TP-16 TV Film Projector equipments.

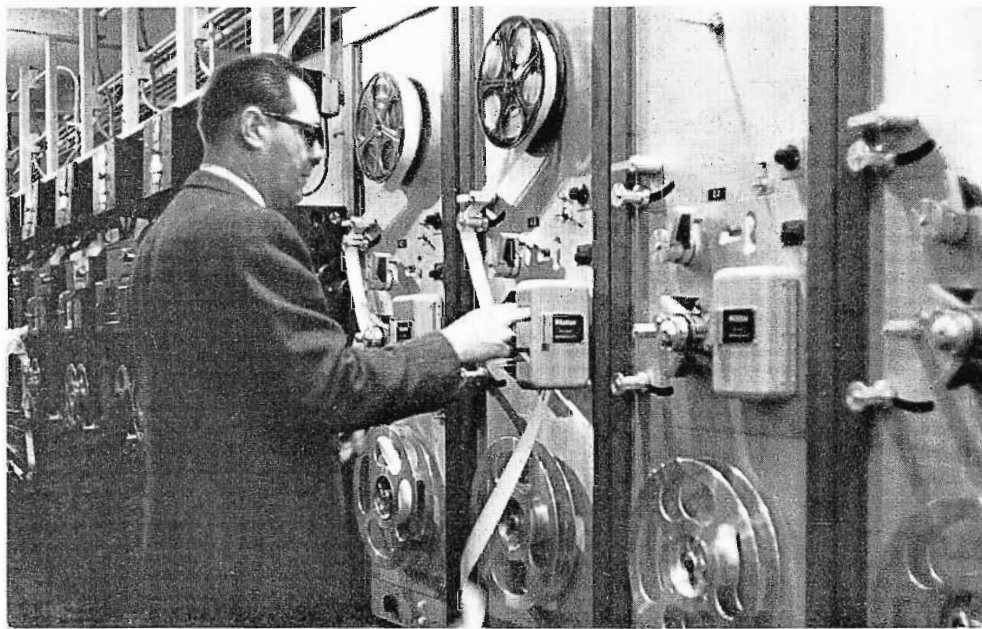

FIG. 13. Sound dubber room, showing several of 40 sound playback machines, which use sprocketed magnetic or optical film. Richard Vorisek loading dubber.

Connections With Sound Studio

The building, which contains the video installation also contains five sound recording studios for sound recording and mixing. All sound studios have been equipped with video monitors and controls to allow the television tape machines and projectors on the video floor to be controlled. Therefore sound recording or mixing jobs can be done utilizing the video equipment as picture sources.

Special Devices

In addition to some of the special devices mentioned above such as interlocks, footage counters, ganged remote control and special monitoring facilities, the installation includes some other unique facilities to do a better job. Some of these are shown on the following pages.

Telephone Company Connections

The New York Telephone Company, partly through the efforts of Reeves has established a switching center in New York. Customers, within New York City, can be interconnected through this switching center. The customers include, besides Reeves, two of the three major networks, advertisers and advertising agencies, and other independent tape producers. Reeves has installed twelve video circuits in the building. Through these circuits, video feeds in either direction can be established to the customers of the switching center or on only a few days notice to anywhere in the United States.

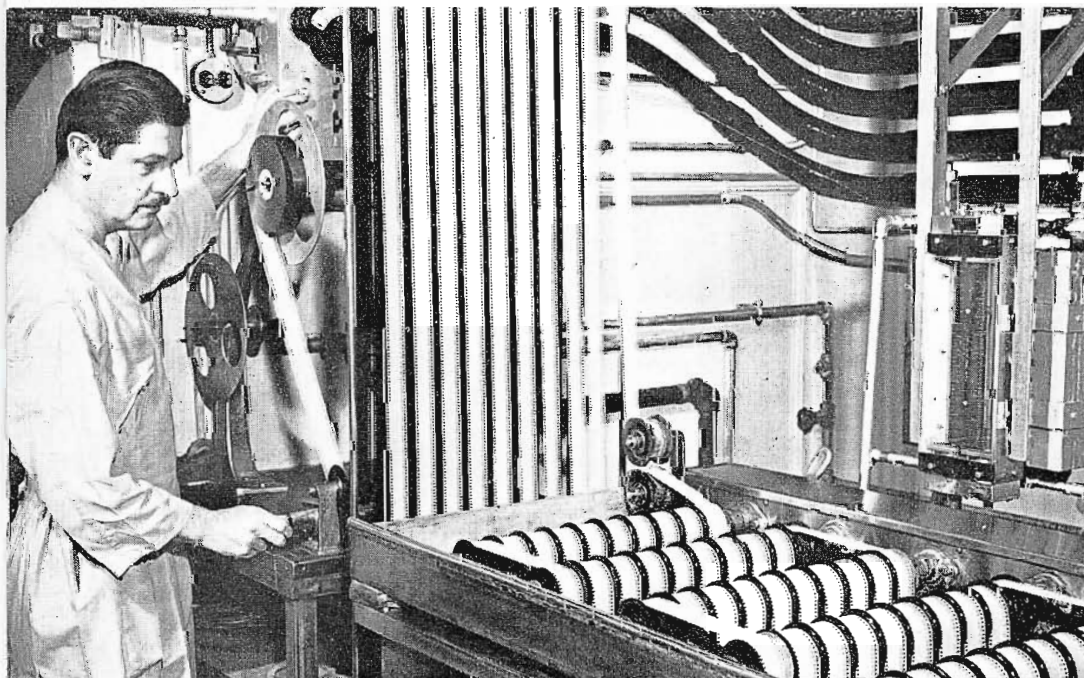

FIG. 14. Reeves exercises complete quality control of film processing. Here is a section of the film developing laboratory.



FIG. 15A. A special lucite cover built over the record buttons to prevent inadvertent operation of these controls and consequent accidental erasure.

FIG. 15. Control panel of RCA TV tape recorder, showing: (A) remote head selector switch for operation in Pix-lock mode; (B) a special 2-step phasing control; and (C) a switch to put the machine in back-to-back operation video-wise without energizing motor drive or record functions.

Services Offered

Tape Duplication

Through the use of eight machines, Reeves can offer a mass tape duplication service, where large numbers of copies of tapes can be made with a minimum of wear on the master tapes. The use of ATC, Pix-lock and air bearing headwheels insures the finest quality tape duplicates available anywhere.

Playbacks

A playback service over telephone company lines to advertisers and agencies is available. This playback can be of tape or film or an integrated program either in monochrome or color.

Recordings

Independent studios with no tape equipment or with only a few machines can

have their recordings made by Reeves through telephone company facilities.

Transfers

Film-to-tape transfers for use in integrating film with a basic tape program can be done in either color or monochrome. For such integration, the standards of the original tape program are analyzed and the transferred material made to these stand-

FIG. 16. View of air bearing head-wheel showing Ed Welsh adjusting head for no scalloping during playback, using a special tool built at Reeves.

FIG. 16A. A close-up of head adjustment tool. This is conveniently available in a holder a few inches from the head.

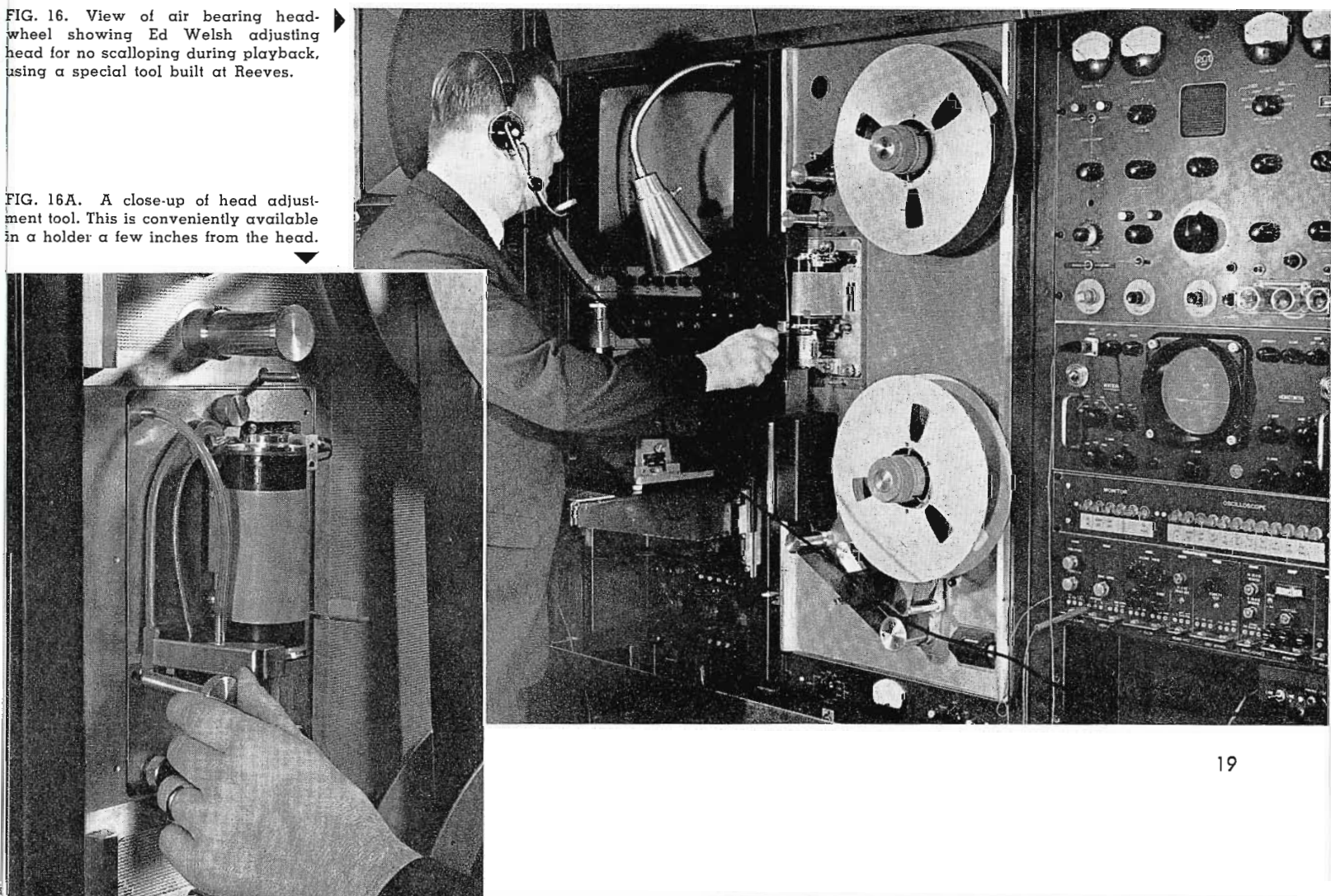

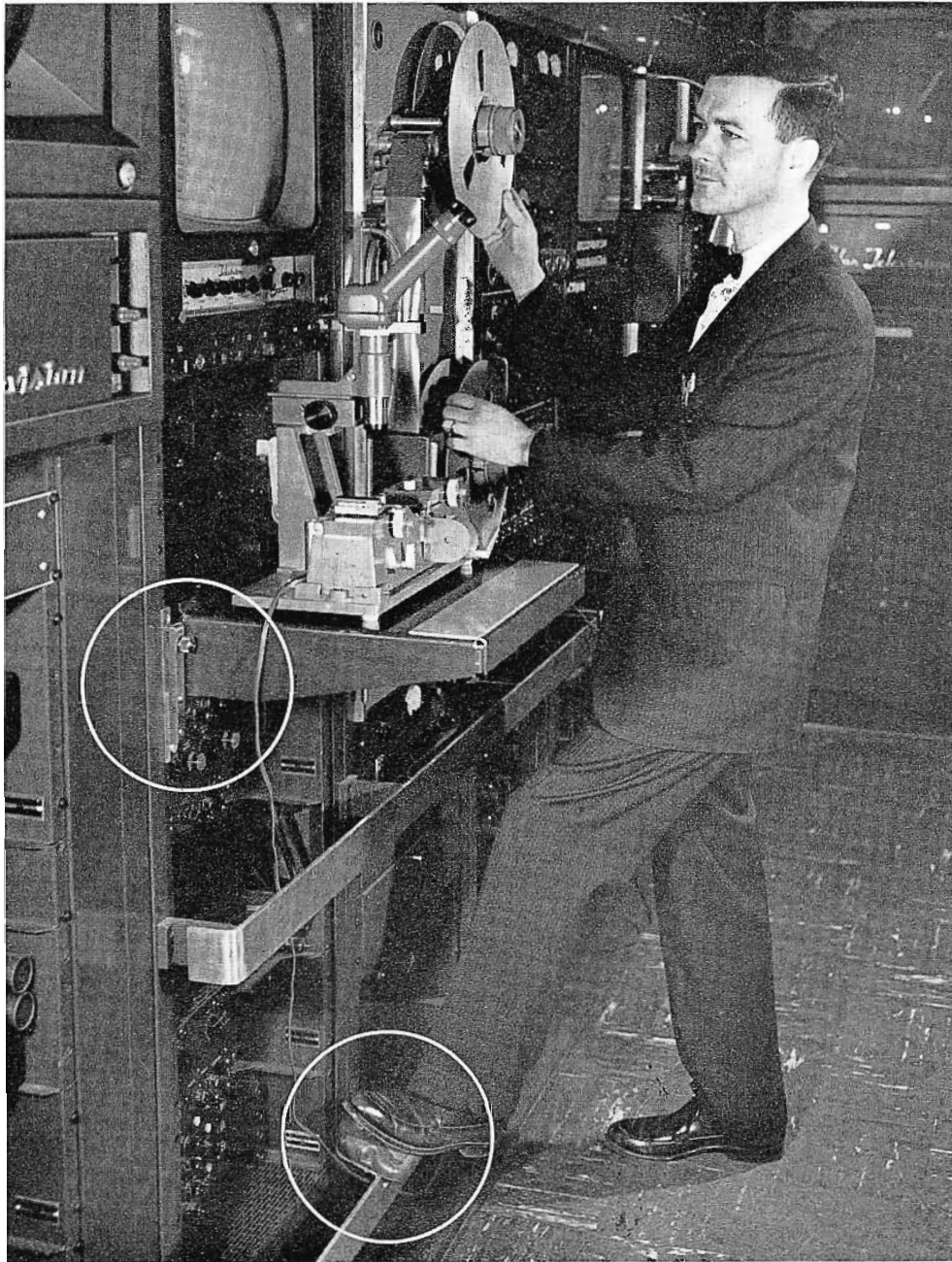

FIG. 17. Note (in upper circle) special brackets built at Reeves for supporting the RCA editing table. Each machine is equipped with these brackets. They facilitate moving the editor from one machine to another. . . . Note (in lower circle) special fixed mounting of the brake release switch.

FIG. 18. A small nose, permanently mounted on each machine, allows holding of the tape tension switch during rewind of tapes, leaving operator's hands free.

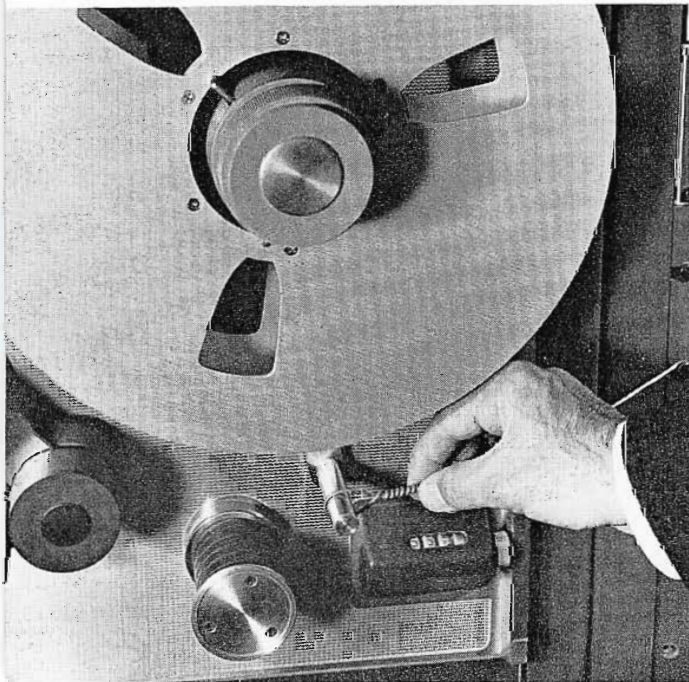
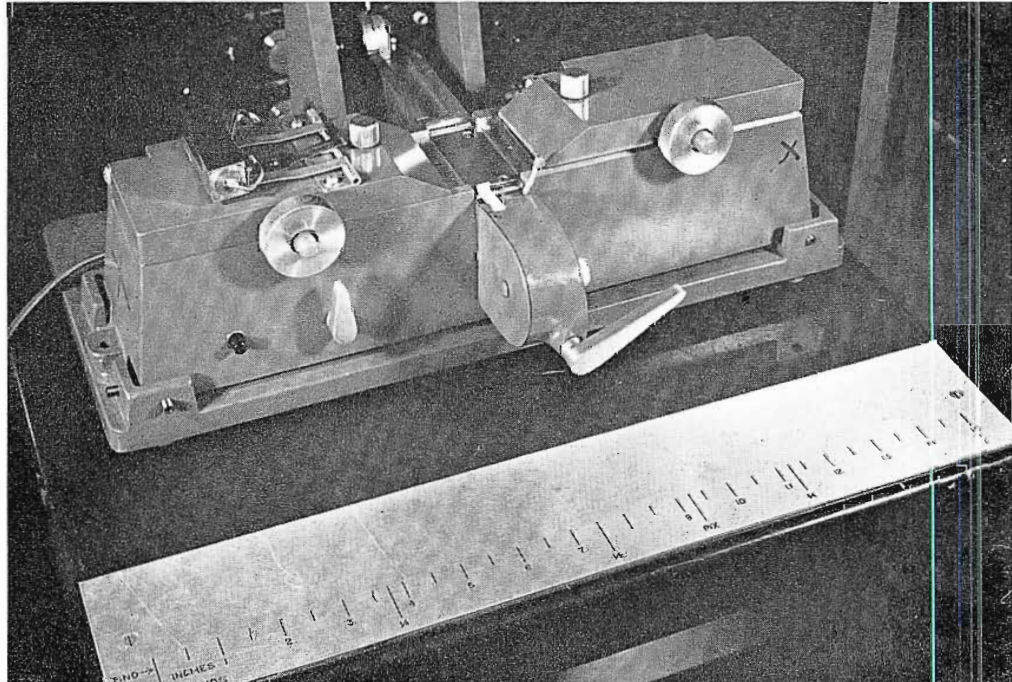

FIG. 19. A special scale on each editing table permits measurement of tapes for editing in fractional seconds and in frames. Also shows the offset between sound and picture.



ards to permit smooth integration. Transfers from tape to film, essential to the syndication market and to the commercial producer, are made using the tape machines, the kinescope recorder, the sound transfer room, the printing room, and the laboratory. Only double system recordings are made to insure that sound quality will be excellent.

Mixing

The installation at Reeves Studios is one of the most complete, most professional and best quality mixing set-ups anywhere. Mixes between several video tapes, video tape and film or live, and between audio sources are done using pre-planned techniques. As much as possible the on-the-fly or live television techniques are avoided, and the need for take after take to come up with an accurate job is eliminated. Quality of sound and picture transitions can be attended to, instead of sweating through the mechanics of performing the basic tasks. The combination of talents of television and motion picture people are utilized to produce a method of approach to each problem, which insures best final product. Wherever possible pre-planning is substituted for on-air panic and the expense of long hours of equipment usage.

Editing

Reeves uses the RCA Television Tape Splicer. This device produces accurately made splices consistently, and excellent results are produced quickly.

Many programs are cut to remove "fluffs," and to make the program come out to the proper length.

Editing skill, more than being a technical process, requires people who can work well with television producers, and who have a good sense of timing. Several of the staff have developed into excellent tape editors.

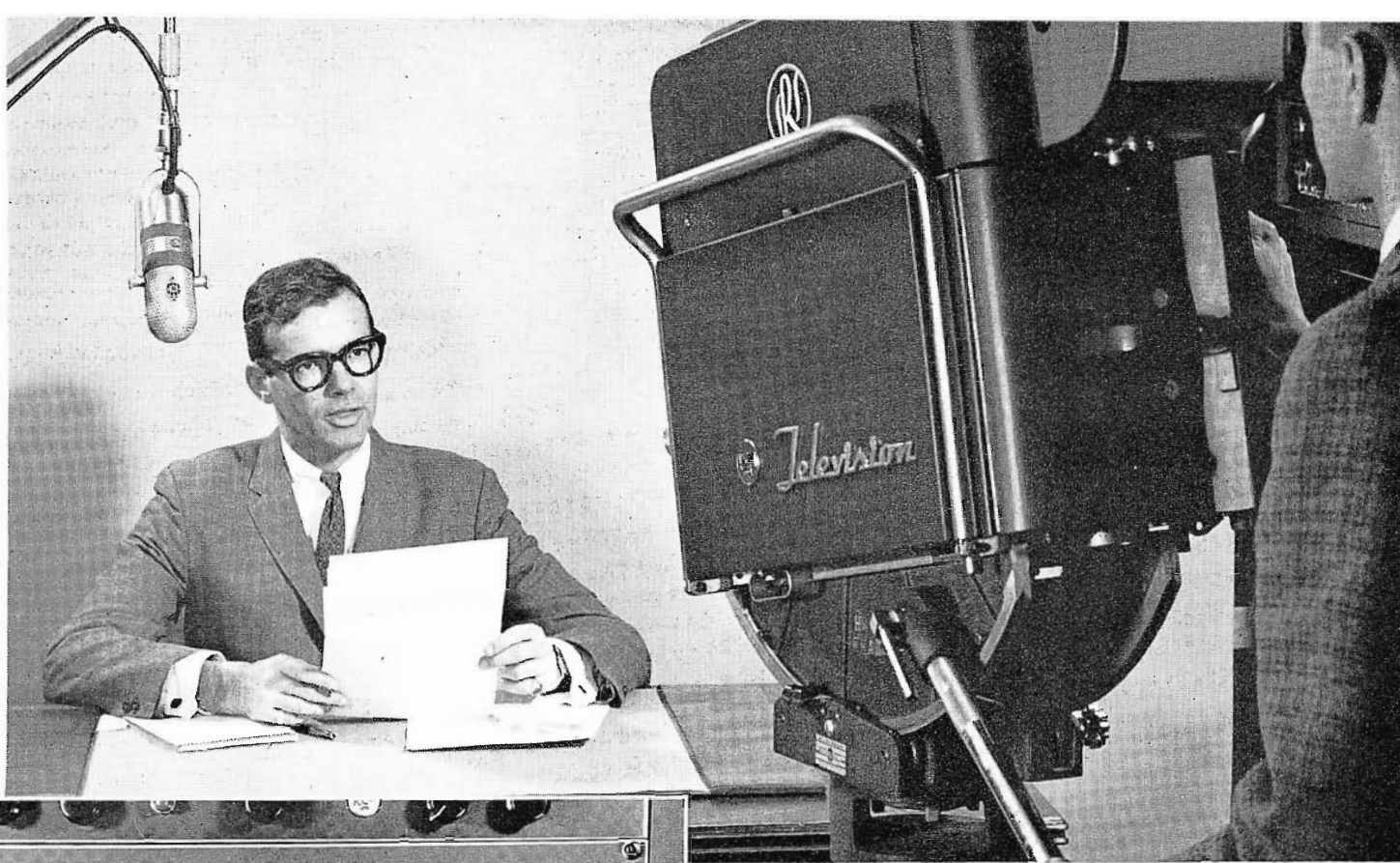

FIG. 20. Type TK-11 monochrome live camera at Reeves Studios is used for simple shots or commentary recordings in conjunction with location or studio recordings.

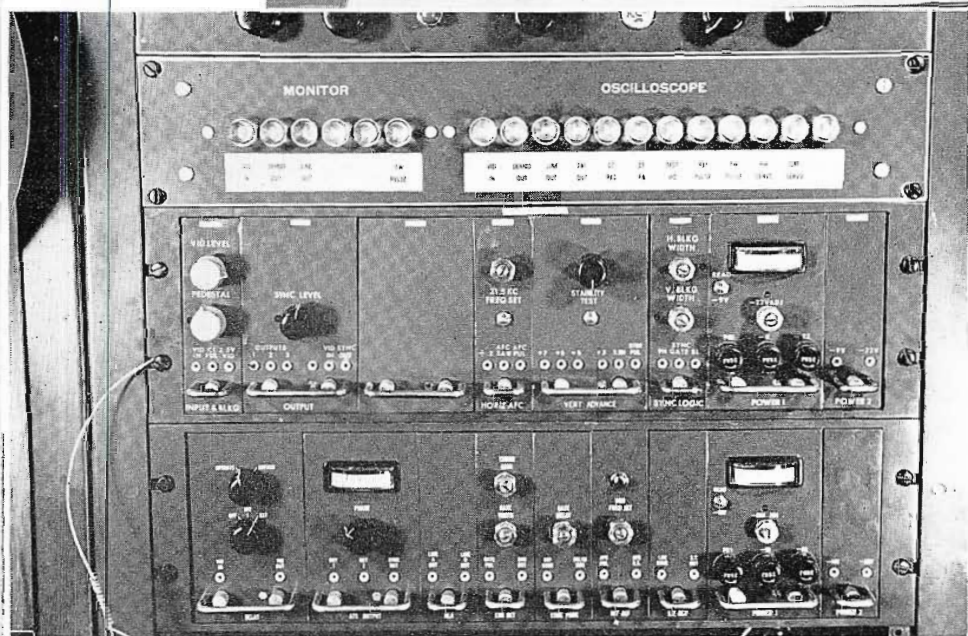

FIG. 21. Signal processing amplifier and A.T.C. unit of one of the RCA television tape recorders at Reeves.

FIG. 22. Audio console (right) and video (left) of mixing studio Y, which is equipped identically to Studio X. Charles Power, maintenance engineer, is shown at TS-40 Transistorized Switcher panel.



Quality Control

Service and quality are the major efforts at Reeves. Quality is stressed to the highest possible degree. This is implemented by having the finest equipment obtainable, the proper measuring tools for quality control, a system of control in all departments, and an attitude of the management and personnel to insist that no job, which does not measure up to standard leaves the premises. Some of the devices used to produce high quality results are as follows:

ATC Device

The Automatic Time Correction equipment recently produced by RCA is being used at Reeves in all playback services. These include kinescope recording, straight playbacks, and mixes. Any geometry problems which exist in the original recordings are eliminated by the ATC. Coupled with Pix-lock, the pictures are brought in exact synchronism with local timing signals so that picture transitions from one tape to another can be performed perfectly. ATC puts a new standard of performance on video tape. In many cases the device allows tapes to be played back at lower tip penetration than at which they were made thus saving wear on tape and heads.

Pix-lock

Reeves was the first to have Pix-lock which goes a major part of the way toward stabilizing playback of video tape. In addition, the Pix-lock unit also produces a much more stable recording than the older headwheel servos were capable of, and it handles playbacks of splices much better than the older units.

Tape Test Equipment

Careful maintenance of video tape equipment is necessary to obtain the best results. Such equipment as a test set to check demodulator limiting, signal-to-noise measuring equipment, and equipment for accurately measuring video track recordings have been built and are used in routine maintenance of the equipment.

Calibrated Demodulator De-emphasis

A special selector switch to give specific amounts of de-emphasis in the demodulator has been installed. Any degree of de-emphasis from 0 to 10 db is available.

Air-bearing Heads

The use of air bearing headwheels produces much more stable recordings when combined with Pix-lock than the older ball bearing types. By substituting a thin layer of air under pressure for standard ball bearings the motor shaft of the headwheel literally rides on a cushion of air. Many advantages accrue, chief being near perfect rotational concentricity.



FIG. 23. Photograph of a tape playback taken from the recorder monitor with tip penetration mis-set. The picture exhibits excessive skewing.

FIG. 23A. The same monitor photograph as in Figure 23 after processing by the ATC unit. All geometric errors have been removed.



Special Sound Services

The present nature of most video tape programs is that of a single system recording where composite picture and sound exist on the tape. This sometimes produces problems when alteration of picture or sound tracks is wanted. Through the use of the interlocked picture and sound equipment at Reeves, sound can simply be stripped from a tape, altered, and put back without any problems of synchroni-

zation, whatever. In addition music scoring against video tape playbacks are made and subsequently mixed with other sound sources to produce final tracks. The matching of non-synchronous tracks to video tapes has often been done. Whenever sound problems exist, solutions can be found for them through the use of the studio facilities. In some cases special equipment has been designed and built overnight to solve problems.

Test Probes

Test probes have been installed on all machine oscilloscopes to make measurement of test points simple and as rapid and convenient as possible. This makes it unnecessary to get out and hook up special test leads each time a check must be made. It saves time and contributes to overall efficiency of operation.

Special Photometer

The production of high quality kinescope recordings from video tape requires the highest degree of quality control throughout the process. The first step is to produce consistent exposure. To accomplish this a special photometer, whose calibration accuracy can be checked by built-in facilities has been built. Consistent densities within .02 are readily obtained using this device.

Control Personnel

Besides equipment, methods and people are of extreme importance in obtaining quality results. In the important areas such as head evaluation, kinescope recordings and tape recordings quality control personnel are assigned to pass on each item. This produces two desirable results: (1) Personnel are acutely conscious at all times of quality, and (2) Customers are aware of the unusual and uniformly high quality results.

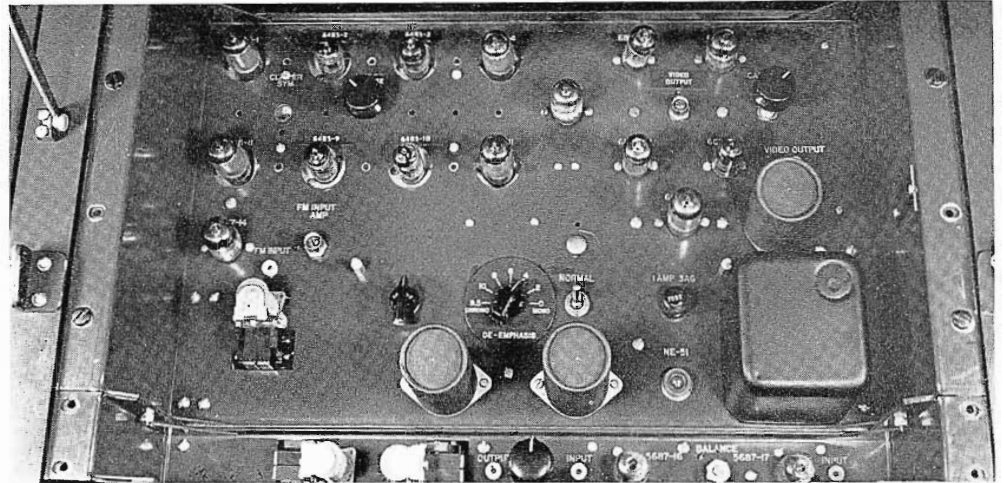

FIG. 24. One of the demodulators of the tape machines showing "calibrated" de-emphasis switch.

Systems and Records

To obtain long range consistency and to be able to check back, a system of records is very important. Tubes are marked with the date of installation, control cards showing parameters used and results obtained for each step of the process are used in kinescope recording, plots of densities of each job are made on a graph to show any trends. Records of head life and wear are kept and graphs are plotted to estimate head life.

Routine Maintenance

A complete routine of every machine is made every three months. This routine is essential for producing quality tapes. Results prove the effectiveness of this system for preventive maintenance. Consistently over-average performance is attained.

Tape Evaluation

Because video recording tape is far from perfect a system of tape evaluation is used, whereby every foot of tape used is recorded

FIG. 25. The servo racks of several RCA TV tape recorders showing the Pix-lock units on each.

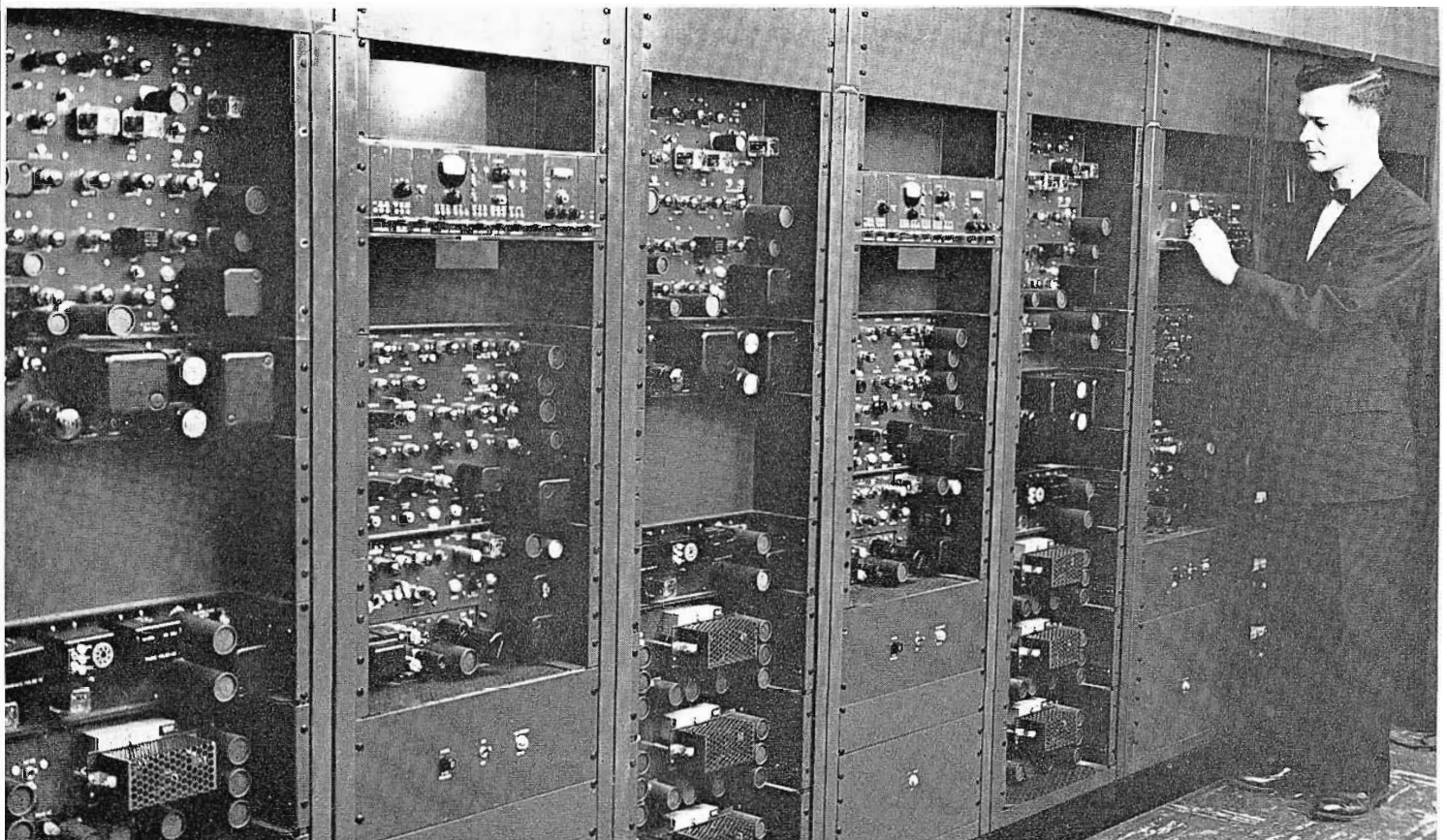

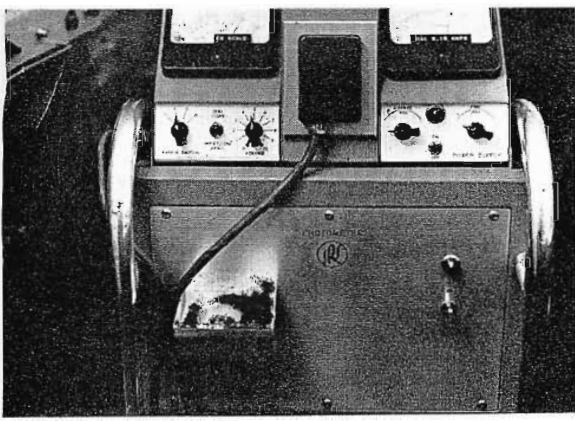

FIG. 26. A specially constructed Reeves Photometer for accurately setting exposures on the kinescope recorder.

FIG. 27. A special rack of audio equipment is used for receiving line audio feeds, processing them, and making them ready for recording . . . Dick Kloss at Reeves intercom system which connects all operating positions and studios.

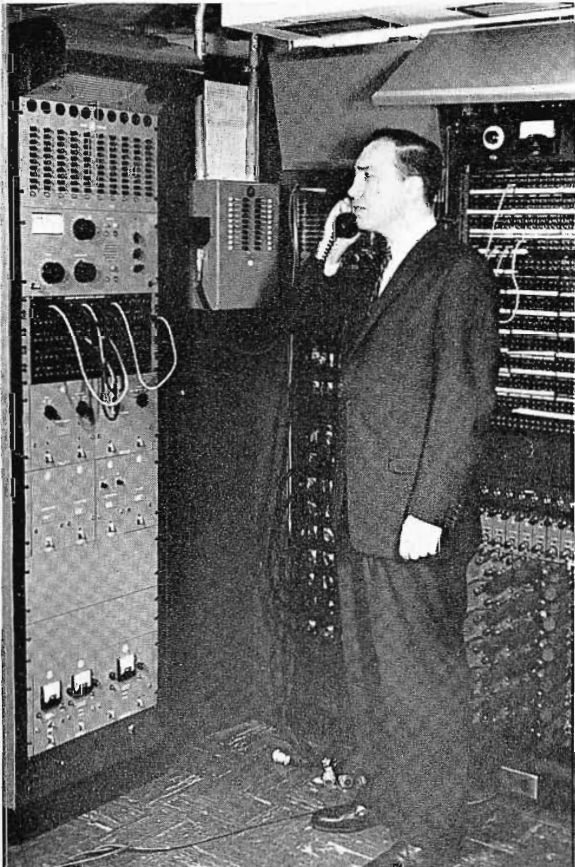

FIG. 28. The RCA special effects control panel in operation at Studio X. Note effects produced as shown on monitors.



with sync and video set-up, then played back entirely. A drop out count is taken minute by minute, and any tape not meeting standards is rejected.

Audio Equalization

Every audio track which is recorded is properly equalized to assure best quality.

In addition to these procedures and equipment Reeves maintains a complete machine shop and an electrical construction shop to provide mechanical maintenance on equipment and to allow the quick design and construction of special equipment.

Examples of Jobs Performed

Recording

A series of one hundred twenty-eight programs was recorded for the Midwest Program on Airborne Television Instruction. The tape evaluation standards of this group are the highest in the country. Not a single tape was rejected.

Playbacks

Many commercials are played back to the larger advertising agencies for their evaluation. All the major advertising agencies use Reeves playbacks. Consistently satisfactory results have been obtained.

Mixes

In a recent mix job for an electrical manufacturer, five tape playback machines, a live camera, and a film chain were used as picture sources. Sound came from the picture source machines and three sound dubbers. The job was done in three takes. All elements were edited in advance so that all equipment units were started simul-

taneously at the beginning of a take and so the mix was done almost automatically.

Sound Sync Jobs

In a recent case a video tape with wavering sound and a quarter inch tape, which would not stay in sync with the video tape was delivered to Reeves. A sprocketed copy of the quarter inch tape was made and a sprocketed copy of the unsatisfactory sound from the video tape was made. The good sound was then edited sentence by sentence to match the poor sound in length. The corrected good sound was then re-recorded on the video tape, and a completely satisfactory program was obtained.

Kinescope Transfers

Most of the commercials made on tape by independent tape producers are transferred to film by Reeves. Additionally hundreds of syndicated programs have been transferred. The reputation of Reeves Sound Studios in kinescope recording is the best in the United States. This has been possible mainly through quality control techniques and because Reeves has its own laboratory.

Post Audio Syncing

Several times, a section of video tape with an unsatisfactory reading by a performer has been post-sound recorded by the actor and the new audio substituted for the old. This allowed the recording to be used without the expense of having to re-shoot the scene. In most cases sound editing was required of even the best take to establish close synchronization of all the words.

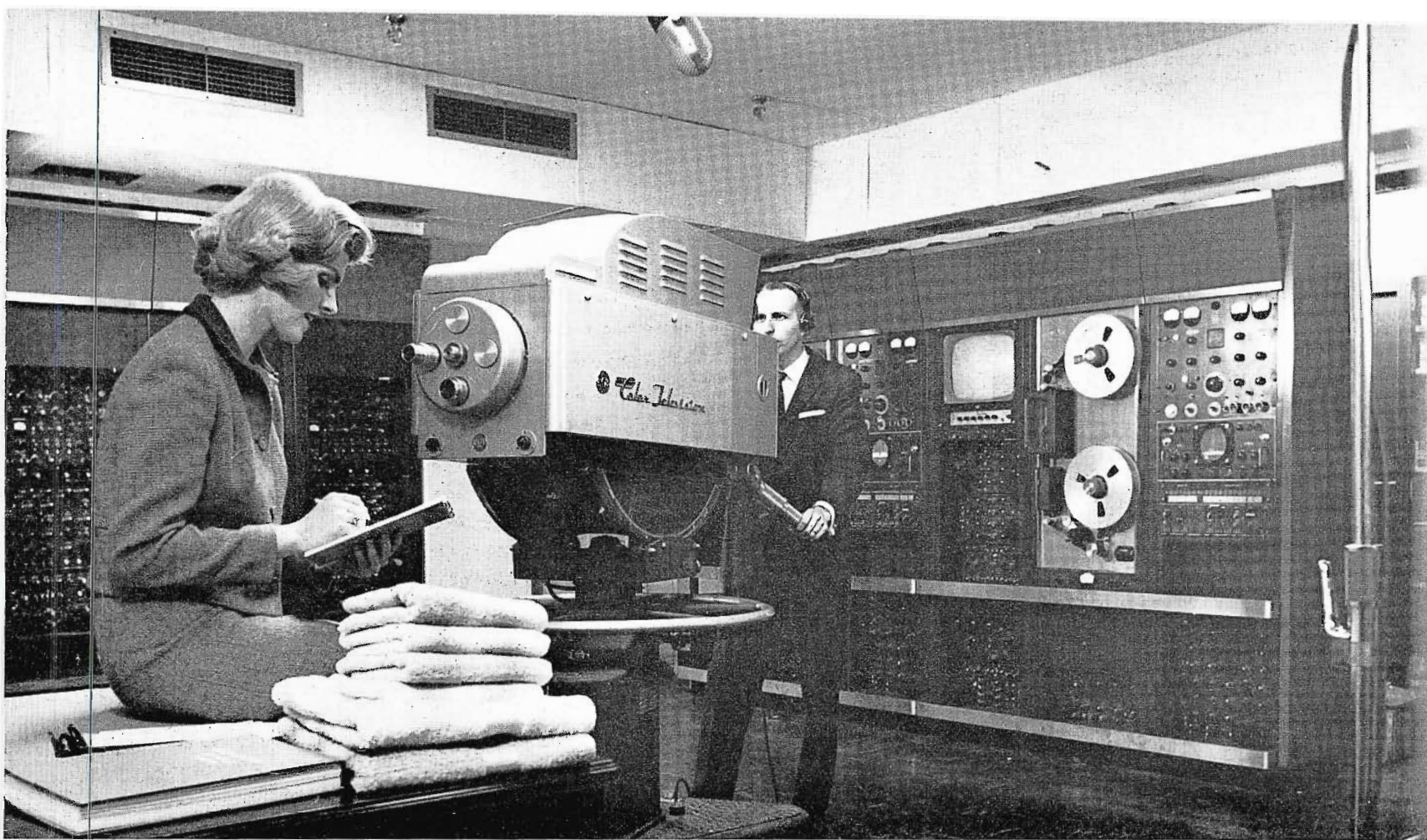

FIG. 29. Color recordings of simple commentary can be made by using the TK-41 live color camera.

Editing TV Tape

An excellent example of this occurred when the first astronaut was orbited by the United States. The pictures were recorded, a twenty five minute show edited, a composite sound track with announcer, location sound, and a few effects sounds was mixed and recorded on the video tape. Then the tape was sent on a 7 p.m. plane same day to London to be aired by the BBC.

Special Operational Methods

In engaging in such a specialty as this there have been developed several special methods of accomplishing desirable results. These "tricks of the trade" have been developed because of the special nature of our business and can be classed generally as methods that take the guesswork out of the business. Reeves avoids almost entirely "on the fly" techniques. Even the syncing-up of tapes is done by measurement. It is possible, therefore, to accomplish very simply and quickly seemingly complex jobs. The best of motion picture and television techniques have been combined to produce a highly efficient operational procedure. The use of the RCA tape recorders with their superior picture performance allows Reeves to bring quality and professionalism into the television tape field.



FIG. 30. The control room of Studio B, the band stage, where many video tapes are scored, Jack Higgins at console.

FIG. 31. An operator loads one of the TP-6 projectors in preparation for a mixing job.

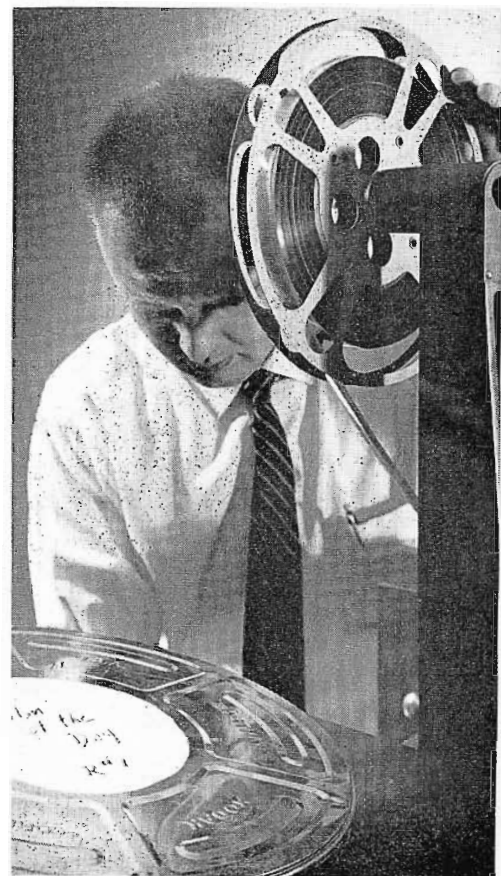

THE ACT OF

We are in sympathy with one half of William Saroyan's statement "the formal theatre is dead and all our forms forever obsolete."

With too few exceptions, the designers and architects who are charged with bringing new theatres into being succeed in creating modern replicas of traditional theatre structures—structures whose very shape, machinery and operation is conditioned on and by archaic, sentimental theatre practice.

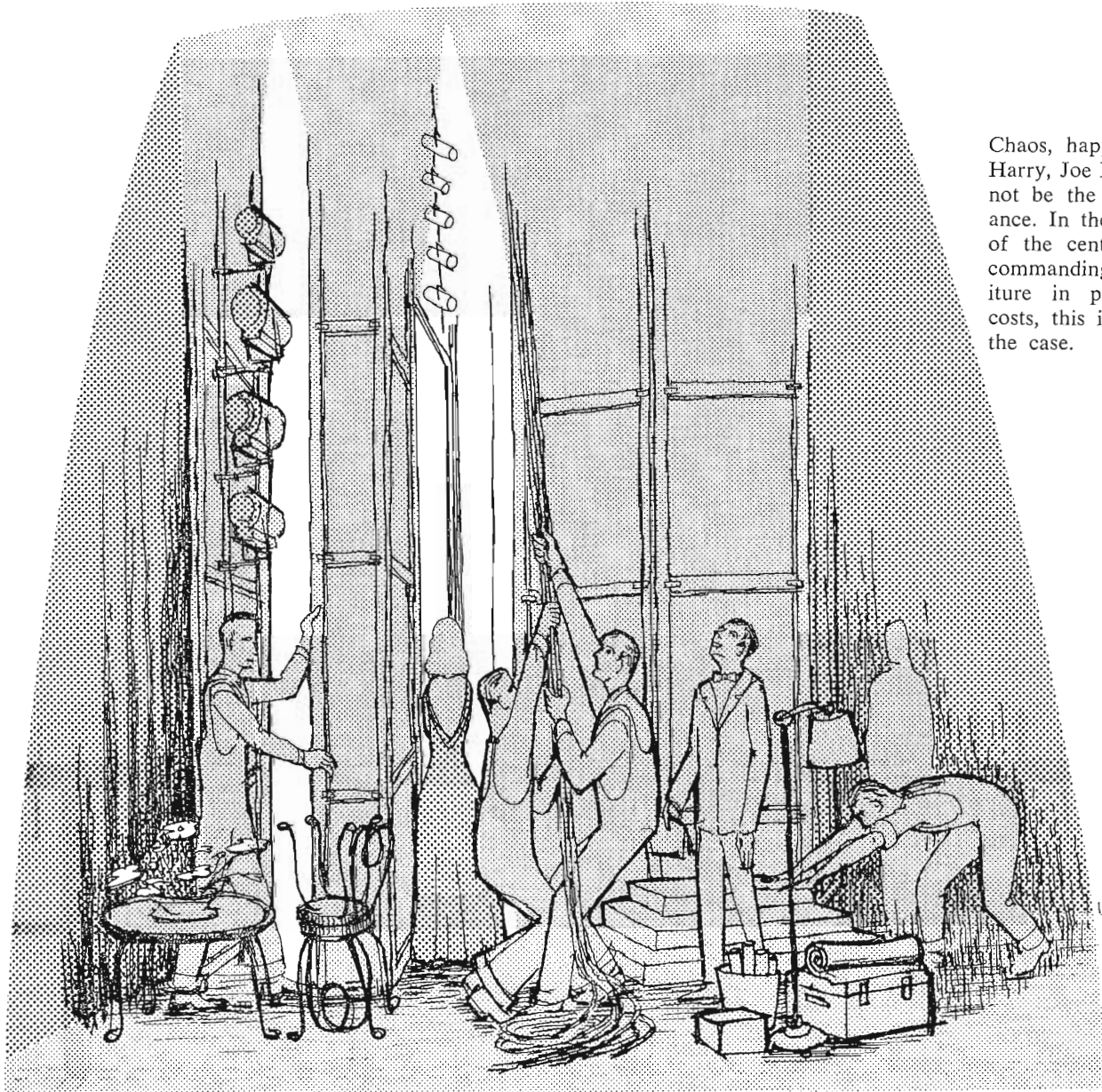

Chaos, happenstance, hair breath-Harry, Joe McGee and luck should not be the precursor of performance. In theatres built at the turn of the century, now in use and commanding extraordinary expenditure in production and patron costs, this is more often than not the case.

THEATRE

By - SOL CORNBERG

This is the story of the "automatic theatre" and, since it is made possible by means of closed-circuit television, broadcasters will doubtless find interest therein. Further, many of the recommended techniques for flying scenery, handling props, and moving electrical fixtures are uniquely pertinent for the broadcaster . . . The author, Sol Cornberg, is remembered as Director of Studio and Plant Planning for NBC. Now heading his own company, Sol Cornberg Associates, he is applying his expertise to the design of tv studios and plants for educators, the military, and broadcasters.

It is not enough to produce traditional structure and practice, which impose parameters on the playwright and are contributing factors to the stultifying and uninspiring current theatre art. New structure must permit—more, must cause—enlightened theatre practice.

A mere handful of people, the playwright, director and show designer are prerequisite to setting the mood and the quality, i.e., the requirements, of a given production. Of the myriad number who will additionally be involved, only the actor and audience should be privileged to impose their emotional well-being on the specific performance.

Extraordinary costs of theatre construction and operation demand that the theatre building lend itself to the well-being of any type of production to the fullest, so that true theatre—the interaction of performer and audience—may be best served.

The proprietor, designer and architect must, as in flying at 700 miles per hour or using an automatic elevator, come to terms with the machine, take cognizance of new materials, as well as new techniques and tools, in handling old materials.

In accepting the best of new technology available, and that yet to come, a fine structure can be built, space controlled, so that the theatre may literally materialize, about the thought, and need of the specific production—may materialize the shape, size, color, decor, and smell (if desired), of the production's requirements.

A theatre plant as sophisticated as that envisioned will not, perhaps, be won in a revolutionary manner. However, considering the many—and some exciting—approaches made on the campuses of America in the past ten years as segue, the theatre in its need for new plant, may well evolve into the space-controlled theatre plant.

The great new theatre would be that one which the proprietor and designer dare to leave unfinished, though operable, and which may in time accept equipment and operating disciplines which budgetary consideration and technology provide.

Operating personnel in front of the house and backstage must be upgraded to, or, by attrition, replaced, with those who are capable of dealing with the space-controlled theatre. We submit that, in transition, known and proven technology introduced into theatres now in use, would deter "the erection of replicas." We further submit that proper and efficient communication between operating personnel would remove their unnecessary emotional well-being from the true "act of theatre," the intercourse between performer and audience.

By introducing closed circuit (inter-com) television into the procedure (as has been done at the St. James Theatre, New York City, among others), operating personnel may for the first time see the show as the audience sees it. All cues: sight, sound and physical, would have reaction time reduced, causing a more desirable blend of all effects, and the consequent heightening of the "act".

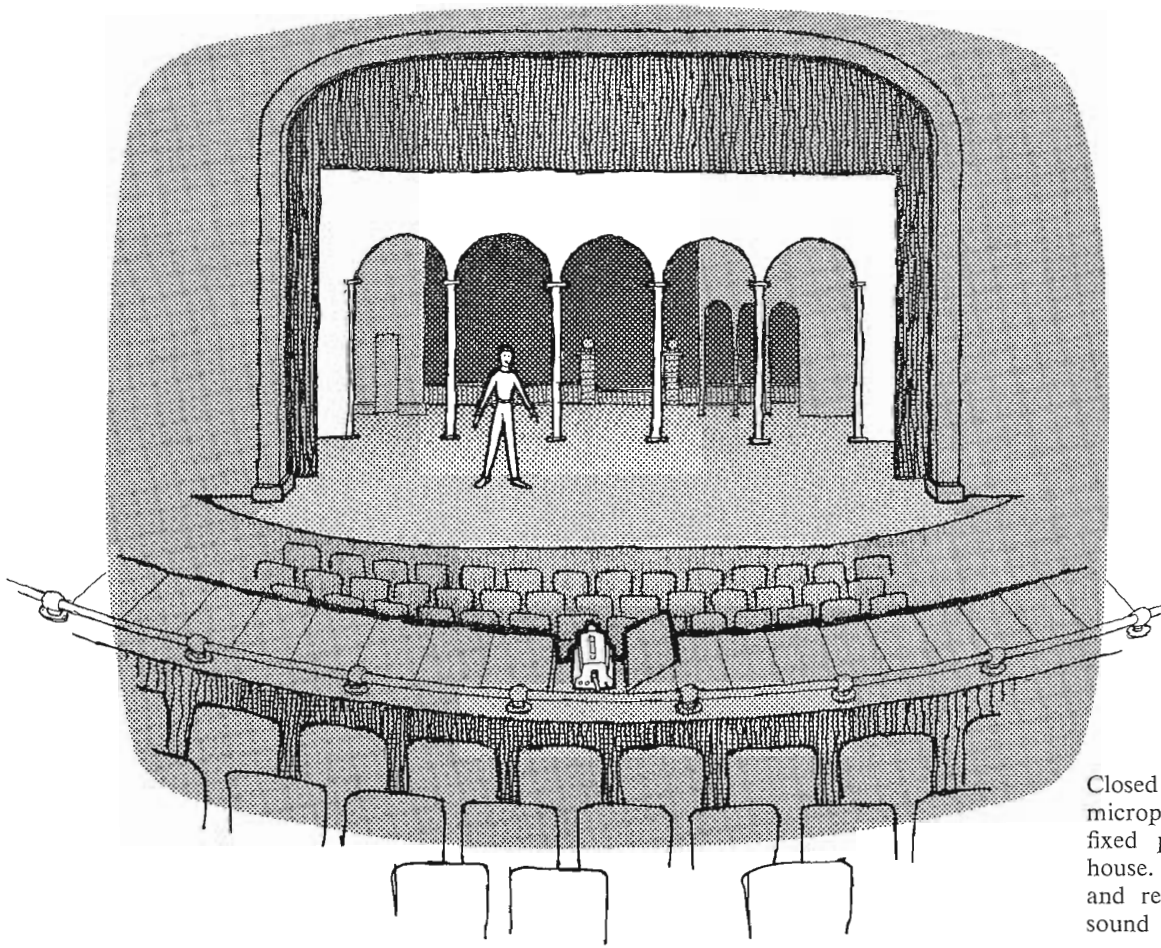

Closed circuit television camera and microphone mounted in a fixed-focus, fixed position, in the front of the house. The camera is self-contained and requires no operator. Sight and sound are distributed by wire.

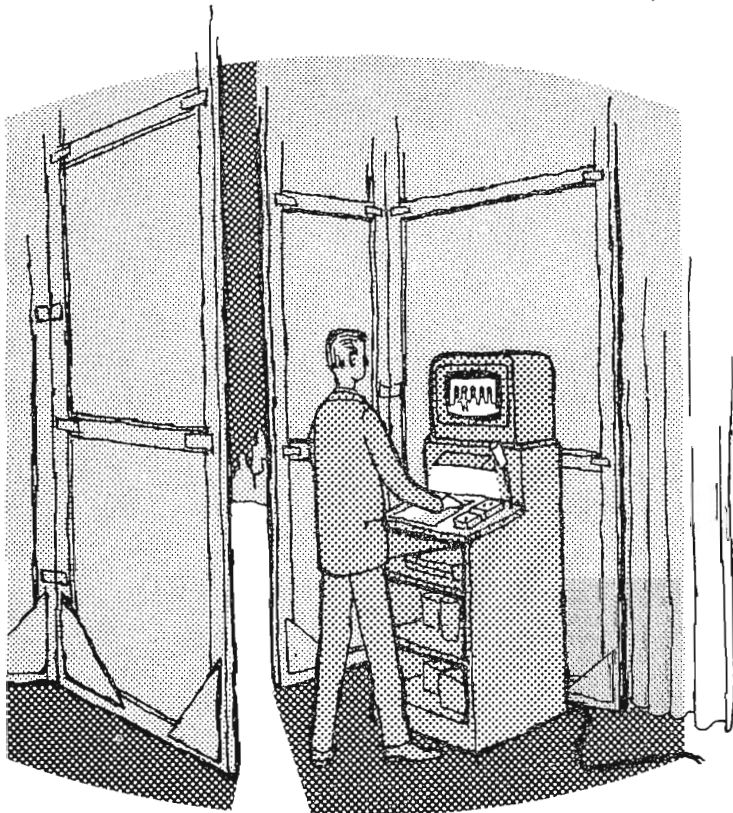

The stage manager sees the show, for the first time, as the audience he is serving, sees it—not, a sliver of stage, through a peep hole in the set or between two flats, but the entire stage. He is now able to "stage manage" the entire effect as directed.

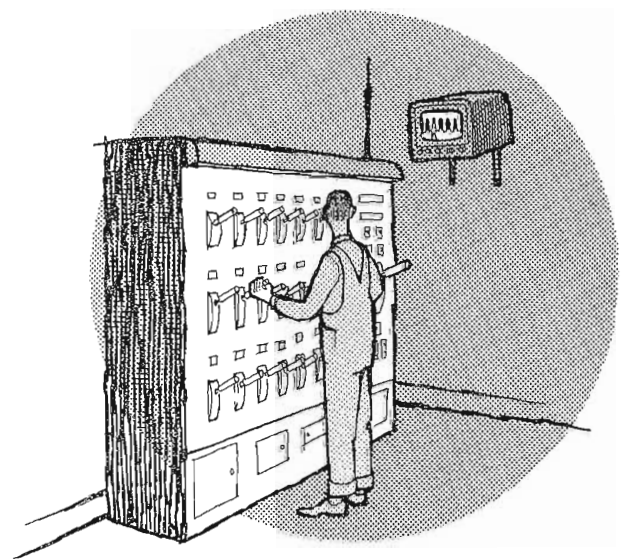

The electrician whose cue comes by audio inter-com or hand signal can now see and hear the stage and actor he is lighting, and in so doing, is in a better position to enhance the values of the actor, rather than to effect a lighting display.

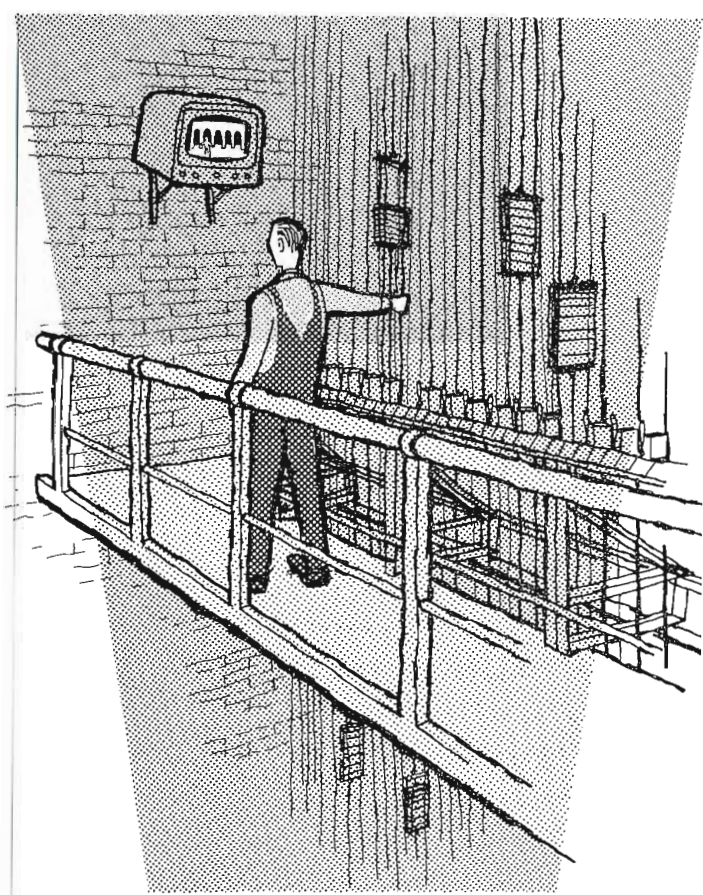

The fly man works in the blind, his cue a shout and a holler, or a series of flashing lights. With scenery moving in and out in view of the audience, creating some excitement to offset weak script or performance, the holler is, as a rule, subdued. With a view of the stage he is less likely to crotch-catch with scenery foot irons, or create a new cleavage in unsuspecting craniums.

The performer in the dressing room is "in touch" with the stage even when changing costume or make-up, and is better able to maintain the mood, and less likely to miss the cue.

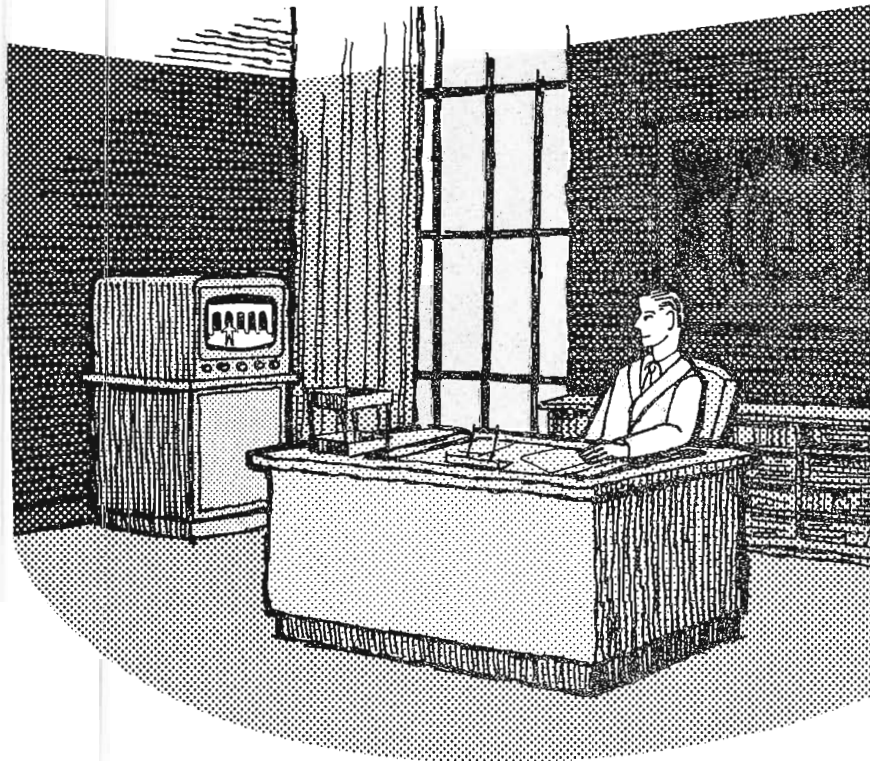
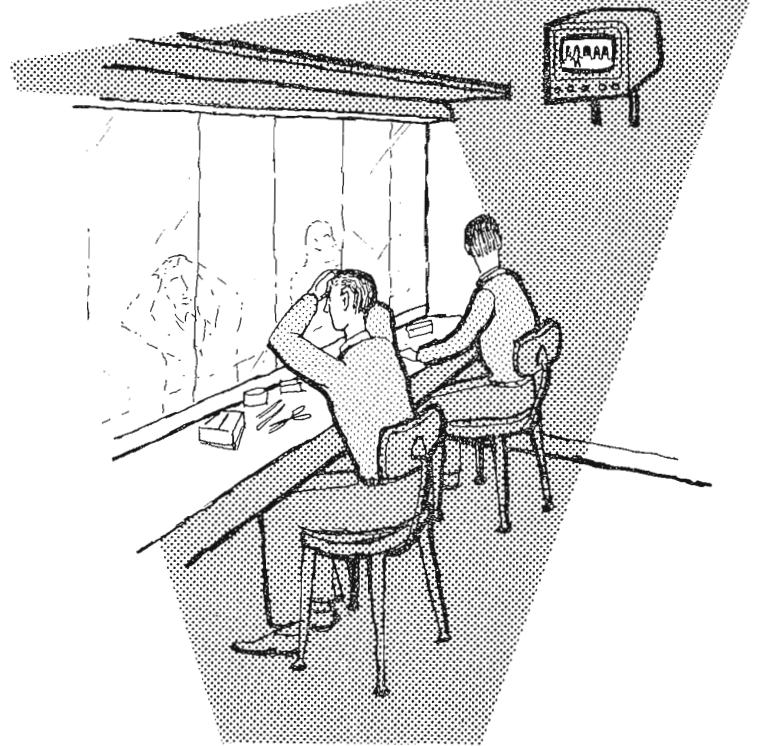

Management at all levels, being in "sight and sound" touch with the performance, may better serve performer and public.

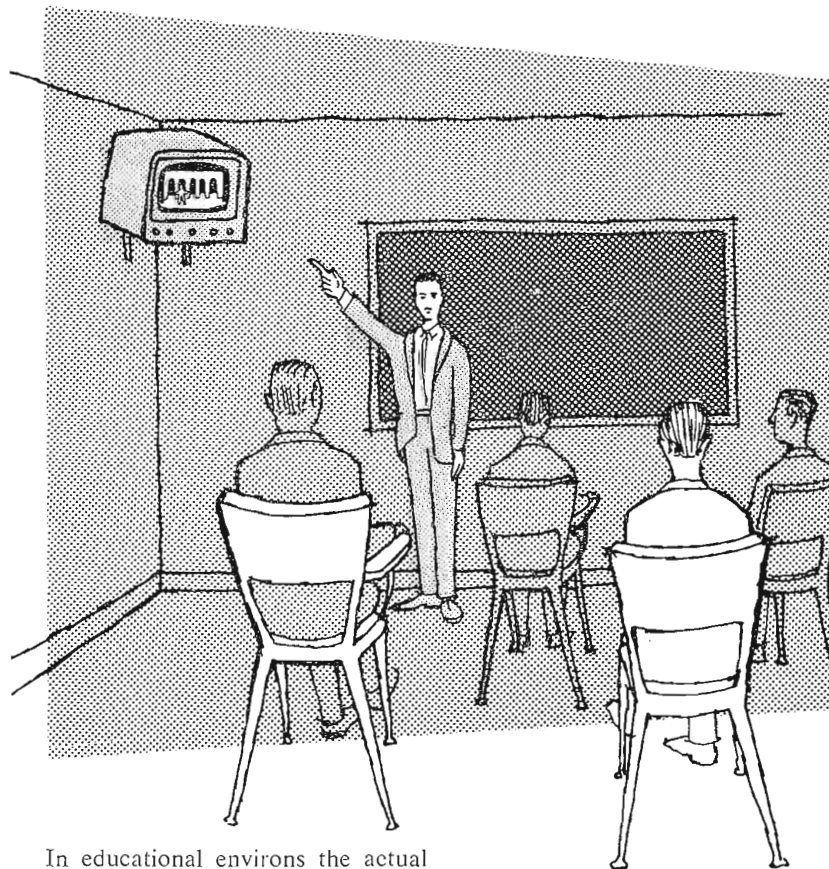

In educational environs the actual performance, performer and public, are the living textbook.

With some precedent and further consideration, the technical operations of the carpenter, fly men and electrician may be mechanized. With brute force no longer a requirement, we may expect more sensitive operators.

Switchboards which by tradition are placed down stage right or left, on stage floor or a balcony off the stage floor, may be installed in a basement space on the base floor slab, close to prime electrical feeders. This saves countless dollars in heavy copper feeds as well as footings and steel cost.

Fly galleries, pin rails, loading rails and curtain lines may be eliminated, with hoisting equipment in flux to meet show requirements. Draperies and flats may be handled as space dividers on horizontal and vertical tracks.

Operators and machines are moved to less critical space, the effect of their efforts being watched by closed circuit television cameras, strategically placed.

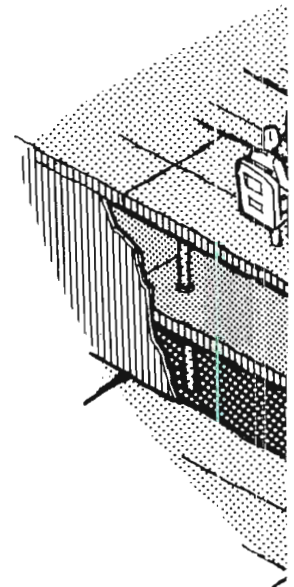
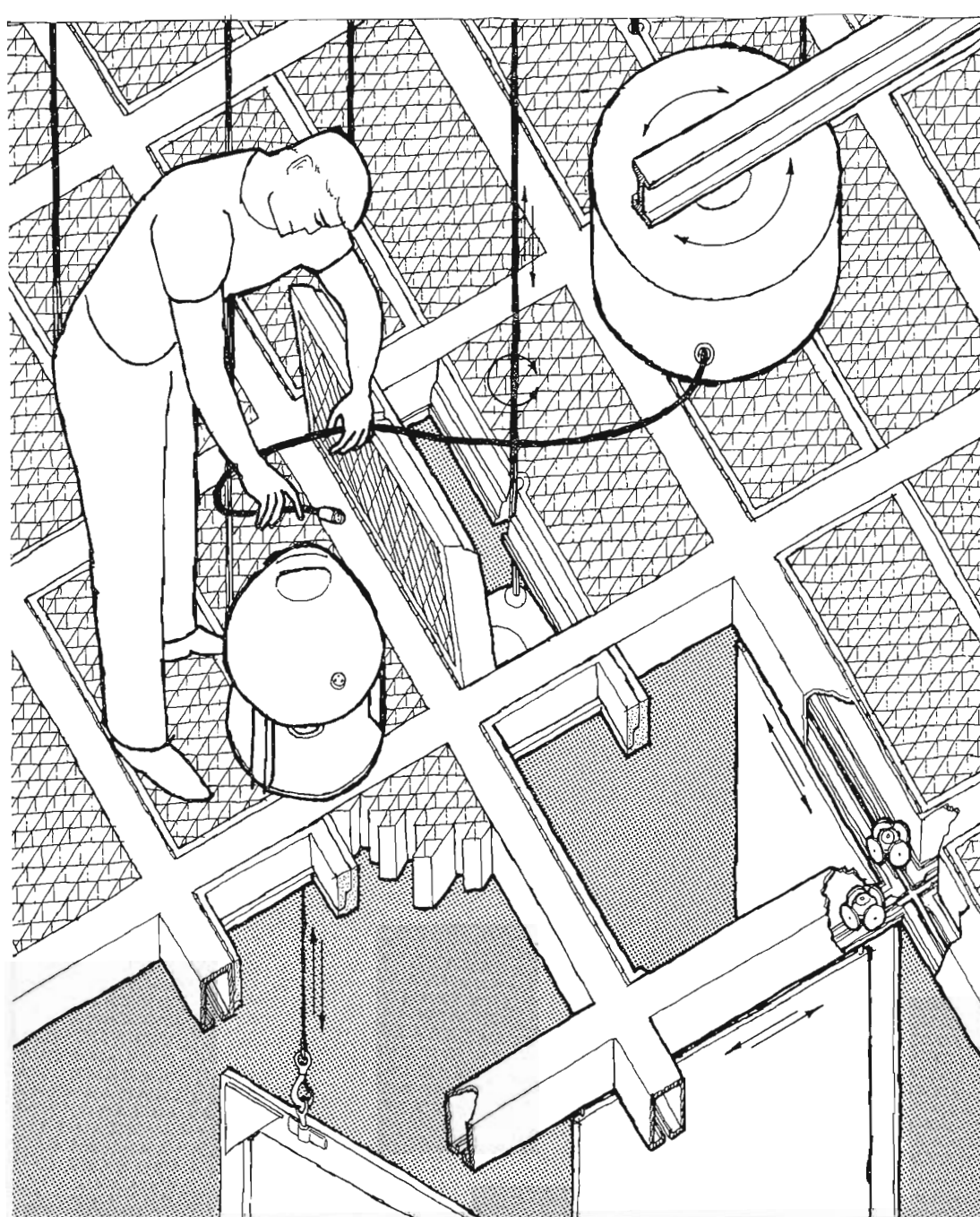

Carpenter, fly men and electrician make their contribution, complete and important, without becoming part of the traffic flow at stage level.

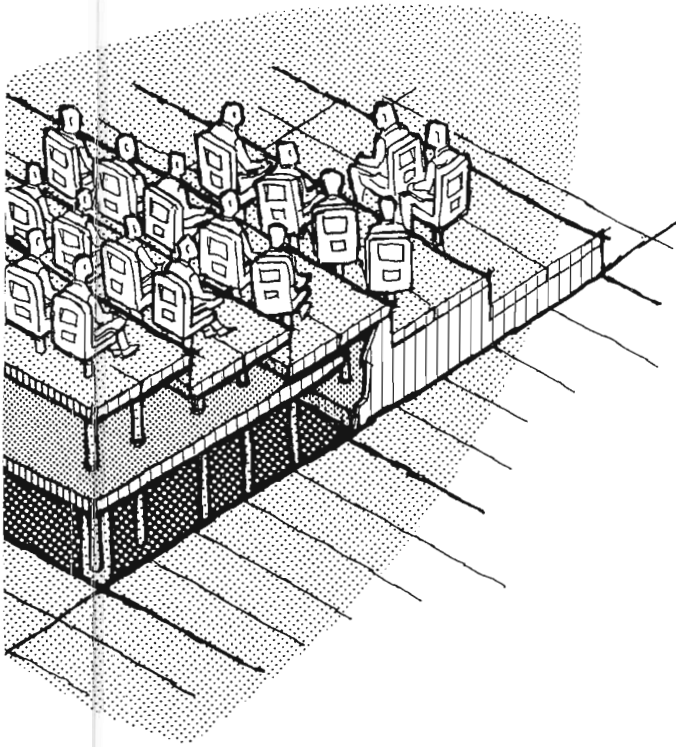
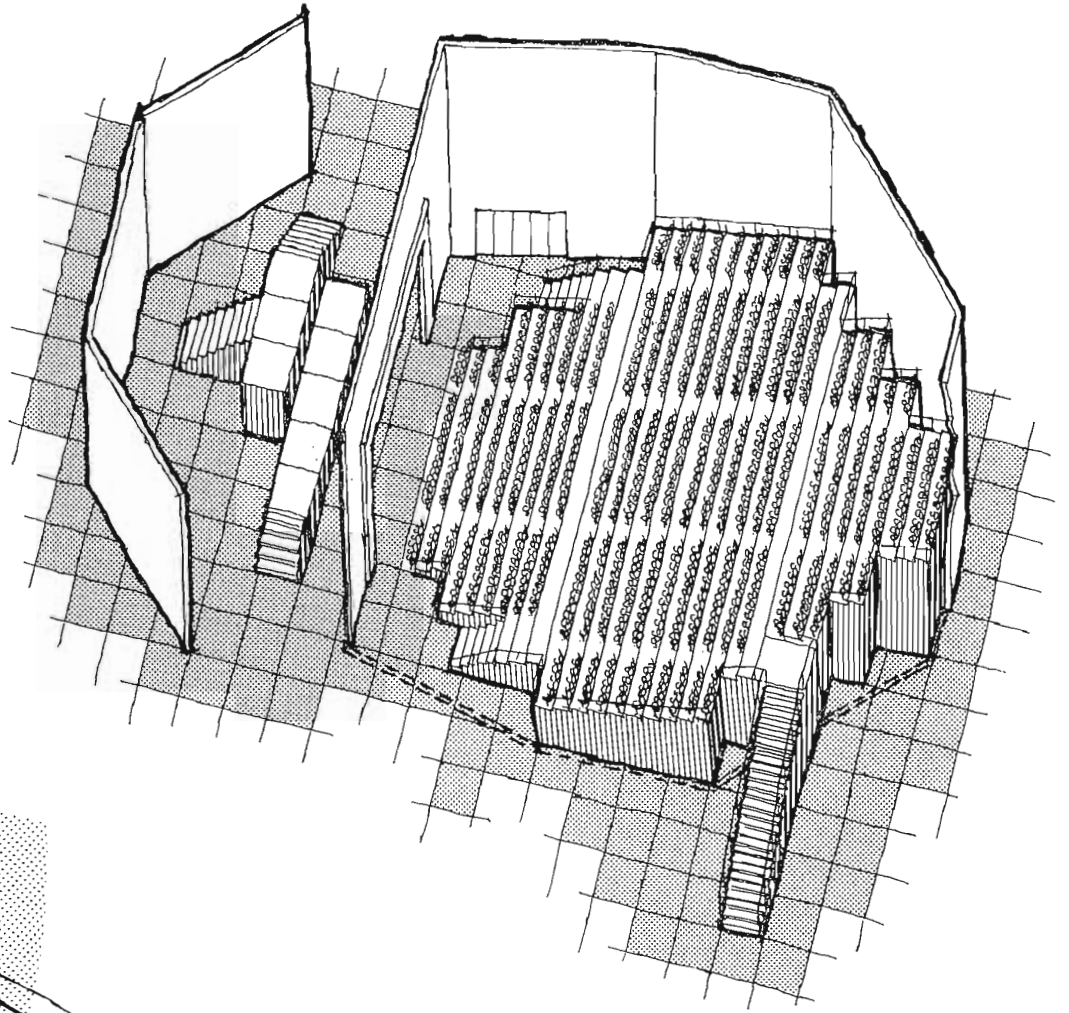

The auditorium itself may be shaped, and color corrected, from the lobby to the stage (as has been done at the American Broadcasting Company, Studio 2, New York City). The audience being emotionally tempered, from the moment of entry into the building, may more readily shed the outside work-a-day world, for the fullest participation in the theatre experience.

Audience seating, in numbers and conformation may be achieved at will, to meet the physical, as well as the economic, requirements of the specific production.

The property man, with his props stored closest to their point of use, may perform his all-important task with the minimum of friction with other stage operating departments.

The stage floor is clear, property rooms and dressing rooms are as close to the playing area as possible. Chorus and mob who change costumes most often, for greatest effect, may do so in dressing rooms at the stage level.

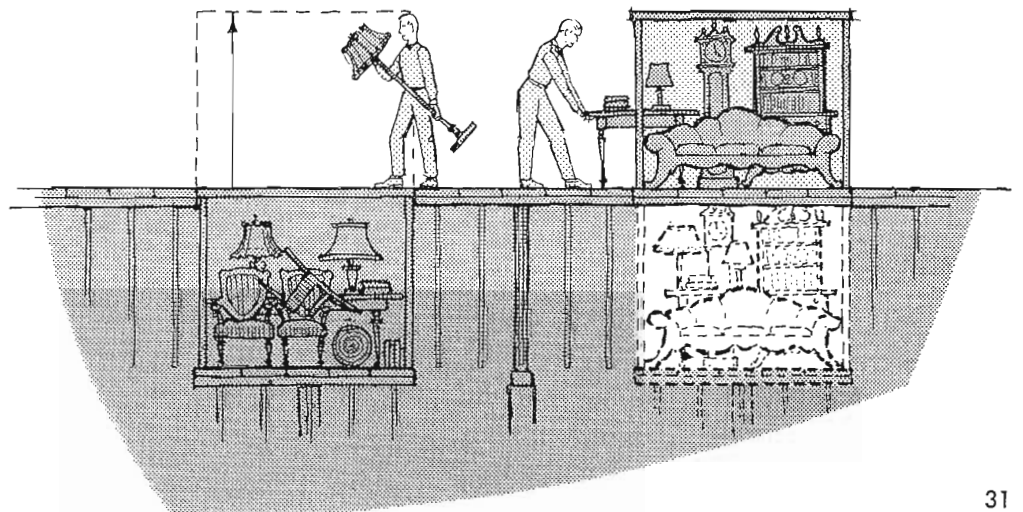

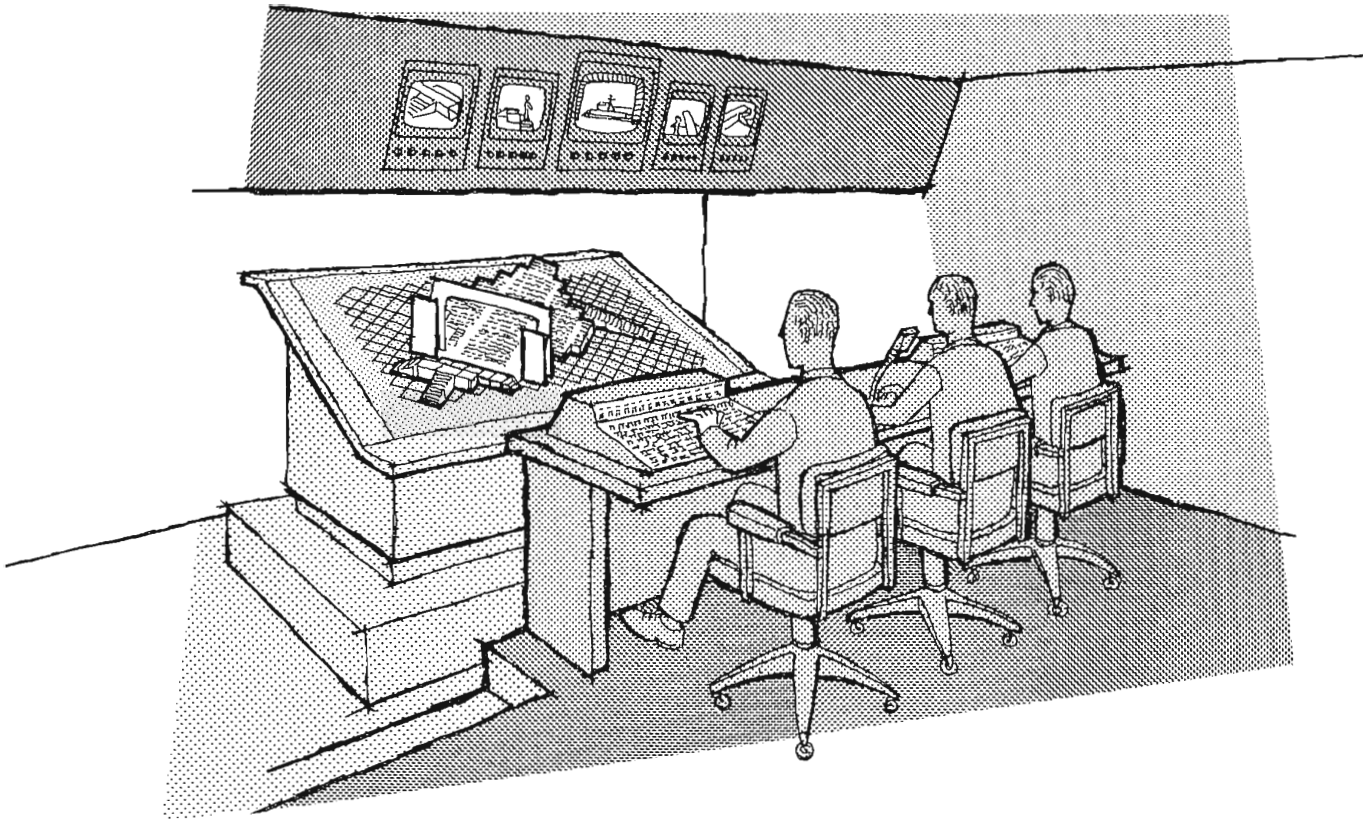

WITH CONTROLS CENTRALIZED, SIGHT AND SOUND EXTENDED, THE MACHINE MAY BE AUTOMATED, AND THROUGH A SIMULATION DEVICE, WOULD DISPLAY ALL ATTITUDES OF THE SPACE-CONTROLLED THEATRE, AND ITS CURRENT PRODUCTION.

Seated before the simulation device, creative directorial and design personnel (there are so few qualified or needed), may shape the physical theatre to the production requirements. Then having tried and erred and tried again, they will feed into the tape or computer playback all cues of the play, knowing that they will be reproduced faithfully, unemotionally, ad infinitum, in quantity, quality and tempo.

During the performance creative operational personnel at Central Control will monitor the machine, over-riding it when necessary to accommodate the varying pace, as of the ever varying reaction between performer and audience.

We approach the desirable, the stage floor belongs to the property man and the performer.

Thus the classical effect from the most sophisticated tool. THE ULTIMATE ENCHANTMENT,

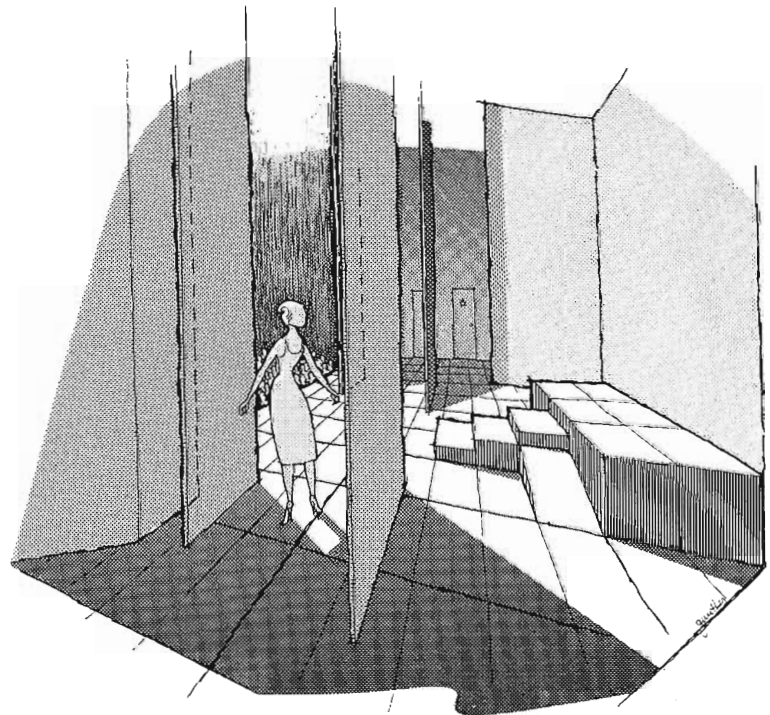

"THE ACT OF THEATRE"



FIG. 1. TK-41 Color Camera views parade from department store marquee.



FIG. 2. "Cherry-picker" hydraulic lift gave spectacular camera angles.

RCA COLOR UNIT STARS IN WBAP-TV STOCK SHOW COVERAGE

For the second successive year—RCA's mobile color unit came, saw and conquered with its colorcast of the 1962 Fort Worth Stock Show and Parade.

Clear skies and warm weather provided a perfect setting to capture the parade. Crowds watching sets in downtown department stores had nothing but compliments on the color tones which had a field day with the bright costumes and blazing parade banners.

Three cameras, two on a department store ledge and a third—mounted in a hydraulic lift, transmitted the hour-long

procession. The "cherry-picker," however, proved to be one of the biggest showstoppers and the most valuable visual facility in the colorcast. Its versatility of being able to swing out or rise 50 feet above the parade gave viewers some extraordinary and colorful sights.

Act Two of the colorful performance was presented at a matinee of the Stock Show Rodeo.

For this live coverage, a crew of nine with four cameras took strategic positions in Will Rogers Memorial Coliseum—the scene of the world's biggest rodeo.

"Although we were handicapped by not having TV lighting facilities," said WBAP's chief engineer Rupert Bogan, "color was reasonably good. Two of the cameras were equipped with the 24415 and 14416 image orthicons; the other two had the 4401 tubes—operating at light levels as low as 75 foot candles.

Thanks to RCA's mobile ambassador, WBAP-TV made a lot of new color fans and as one letter stated: "Your colorcast of the rodeo and parade were magnificent. They were worth the price of my color set."

ANIMALS STAR IN WBAP-TV SPECIAL

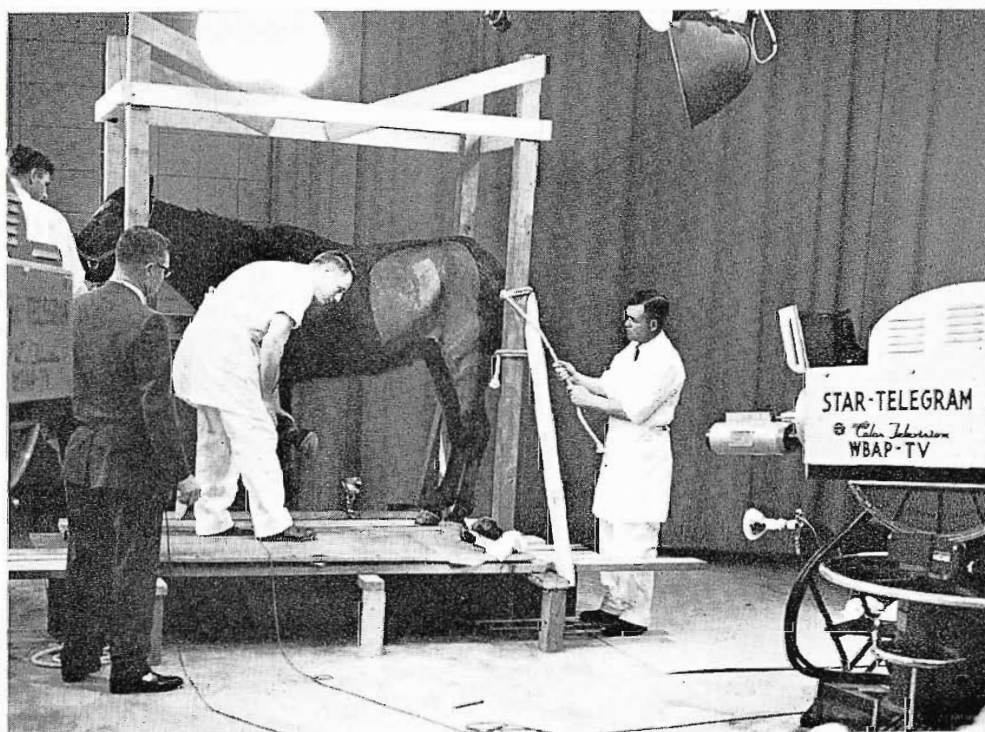

FIG. 3. Veterinary surgery closed circuit color telecast from WBAP-TV studios.

At the exact time "Young Dr. Malone," was beginning its daily episode on NBC and WBAP-TV in Fort Worth, Texas—another medical drama started to unfold in the Channel 5 studio.

Unlike the network program, however, the local thespians had not rehearsed and the viewing audience consisted of only 400 people. The small audience didn't reduce the station's rating, though, for the spectators were members of the Texas Veterinarian Medical Association who were watching their first closed circuit colorcast of animal operation techniques.

Gathered in the grand ballroom of a downtown hotel some seven miles away, the vets—here for their annual convention, spent three hours watching their colleagues introduce the new techniques on the actors—a horse, three dogs and a cat.

Using two TK-41 color cameras, four monitors and a special studio telephone to intercept any clinical questions, both the TV production and the animal operations proved to be a big success.

KSTP

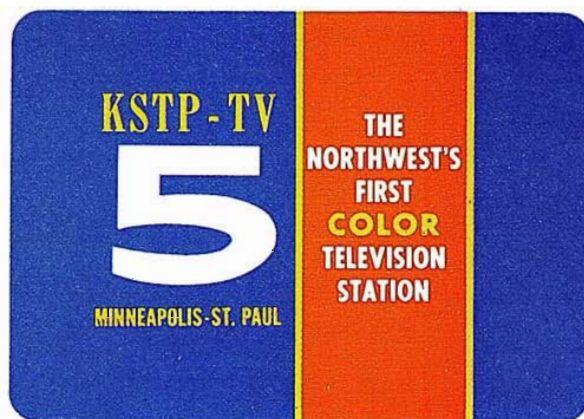

CONTINUES PIONEERING TRADITION IN COLOR, PUBLIC SERVICE AND EQUIPMENT INNOVATIONS

FIG. 1. (left) Mr. Stanley E. Hubbard, founder and owner of KSTP, one of broadcasting's foremost pioneers. He is president of KSTP and manager of the TV operation. (right) Mr. Stanley S. Hubbard, upcoming son of the pioneer, vice-president KSTP, and manager of the radio operation.



In June of 1939, KSTP purchased one of the first TV cameras in the U.S. and began experimenting with television. On April 27, 1948, commercial TV operation began from a location astride the Minneapolis-St. Paul line. Success of the venture is attested by continued growth since that time, developing more business, new buildings, larger audiences. The latest improvements during 1961 make the station one of the nation's greatest and the first in the region with complete color television facilities.

Pioneering has become a steady diet for station KSTP, expressing the rugged individualism of its founder, Stanley E. Hubbard—who has fathered many "Firsts" since the early days of radio: First to establish a complete news bureau; first to create a special events department, equipped with mobile units; first to serve his home community with a full-time educational department. This public spirited attitude, coupled with a vision for greatness, has won the loyalty of the twin-cities audience and the admiration of its businessmen.

Common Problem

Before the 1961 improvements, KSTP found itself in the same position as many other TV stations that have "grown like Topsy" since the pre-freeze days. Office quarters were cramped, equipment areas

were crowded, operations were hampered by old and inadequate procedures. These conditions were caused by increase in transmitter power, additions to the film facilities, need for more studios, and installation of a tape recorder—all signs of a booming business, but all contributing to the operating dilemma.

Modern television installations have eliminated the multi-room concept for technical operations, such as was common a decade ago. A significant saving in operational convenience and manpower requirements can be obtained by combining the switching, film, tape and transmitting facilities into a single area. From here all network shows and many local programs can be handled without needless duplication of effort.

Unique Approach

KSTP had been planning to enlarge office quarters, add additional studio facilities, while providing for color television. A new approach, suggested by Walt Varnum of RCA (after conferring with KSTP engineers and making a systems study) was to provide space for all technical facilities within the confines of one large area and on one floor level. This idea was adapted by Stanley E. Hubbard. The firm of Hammel and Green, Architects and Engineers, was chosen to develop a suitable design for the building and the remodeling.

New Building

The solution was resolved into an addition, housing the unique engineering center studio control areas, a new color studio, make-up and dressing rooms, prop storage, public lobby and entrance for studio visitors. This addition is a windowless building of steel structure and masonry walls. It adds 20,000 sq. ft. of area.

In the existing plant certain difficulties had been experienced due to "RF" in the area, so the entire engineering and control center is enclosed with steel. The floor and roof of these areas are of cellular steel suitable for use as wiring conduit areas. The masonry walls are lined with an acoustical metal wall panelling for a continuous steel enclosure.

Housed in the engineering section are the control rooms for the two large studios (new and existing), announce booth, engineering repair and the electronic gear for operating the television station. The new arrangement provides for central operation of all these functions: Live and film camera control, video and audio switching, film projection and TV Tape operation, transmitter monitoring. The engineering center is one large open space with controlled

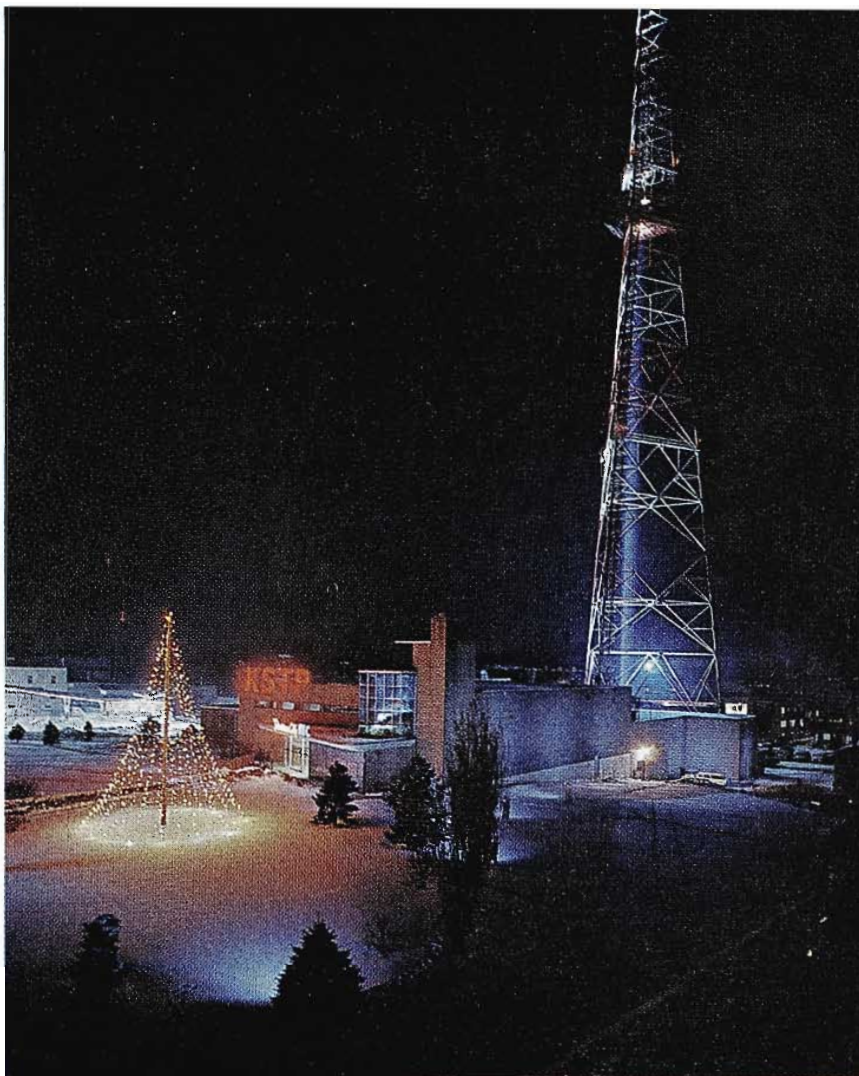

FIG. 2. How the new KSTP building appeared to station visitors during the Christmas holidays 1961, shortly after completion of new facilities.

lighting suitable to the task taking place in that particular area of the room. With this arrangement, any failure in equipment can be most readily attended to.

Serves the Public

Stan Hubbard's philosophy of success is short but pointed, "If you properly serve the public interest, profits will take care of themselves." With this in mind, Mr. Hubbard built the first television station in the northwest and developed it into the veritable television city that it is today. In addition, he has since acquired KOB AM-TV in Albuquerque and WGTO in

Cypress Gardens. "Public service", says Mr. Hubbard, "is a good reason for going into color."

"We decided to get color facilities in order to be part of the growth of this new industry, and because we want to give the public this wonderful service.

"Today, as in 1949, we are following the lead of General Sarnoff. We think it is the wisest course to follow.

"We believe that television is here to stay. It's the greatest medium. And color is part of that great medium."

FIG. 3. In 1939 KSTP procured one of RCA's first commercial TV cameras and began the experiments that led to establishing the Northwest's first TV station in 1948.



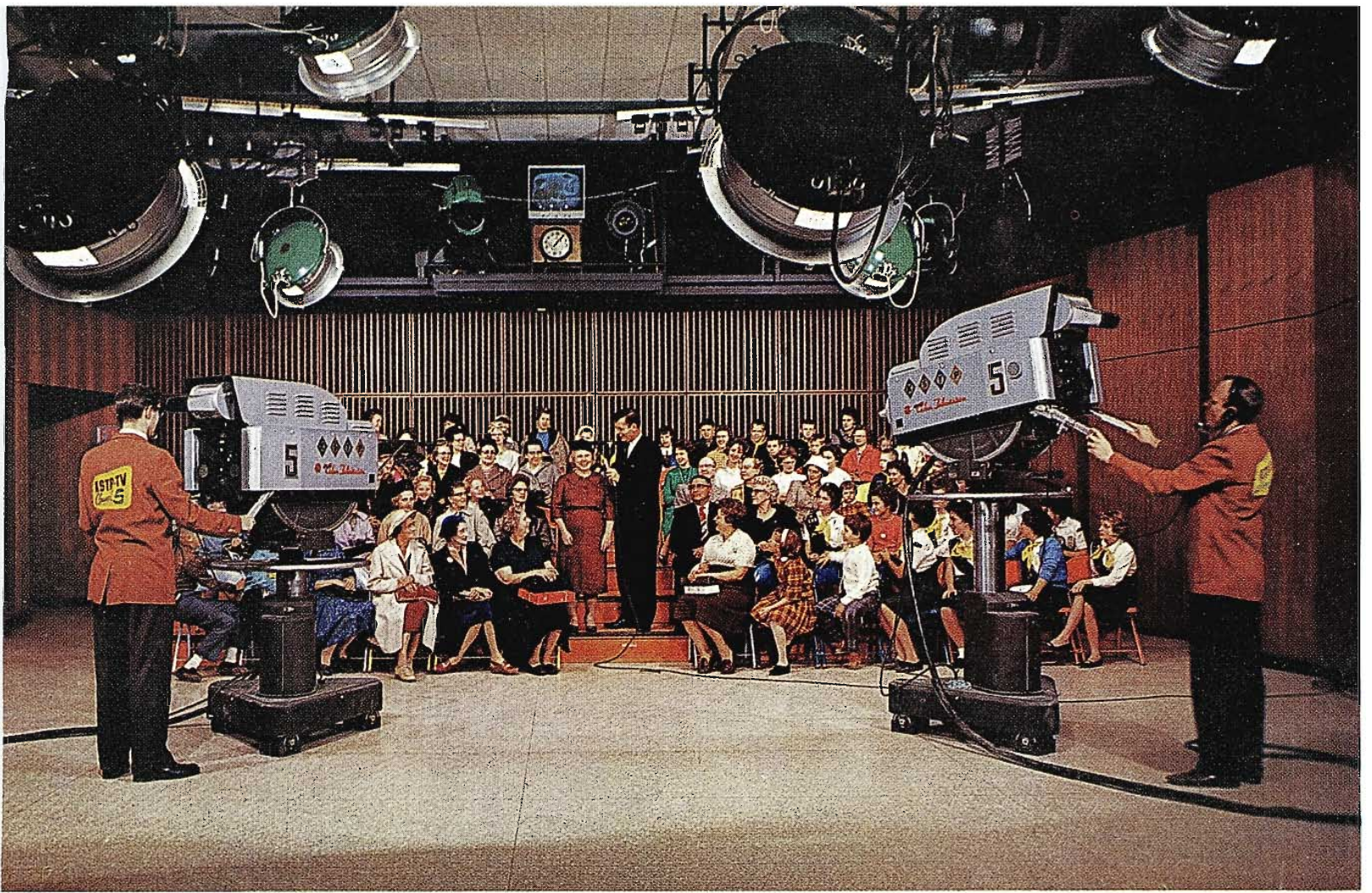

FIG. 4. Emcee Jim Hutton is handling audience participating sequence of live color show "Treasure Chest". It's very popular with the ladies, attracting a daily audience of 100 to 150. (This view shows auditorium section of new color studio.)

Emphasis on News

In the old days, Stan Hubbard put out the news himself on his radio station. A one-time reporter, he had his own ideas, and developed a definite format.

"We make a business of news! It's not entertainment—so there's no music in the beginning.

"We have 41 people on our staff for news and photo reporting. Thirty-seven

pieces of equipment are operating, including two planes, three TV mobile units and a 35 kw emergency lighting unit. Dispatchers listen to all the various communication frequencies—so our men get fast to places where things are happening.

"People have come to depend on us for news. We editorialize only on important issues—however, we report both sides of every issue. Our news is highest rated in the U.S. (Nielson, ARB, and Pulse)."

Economics of Color

"We consider color television a must", affirms Stan Hubbard, "in order to protect our investment.

"Television has been a growth business with sales increases every year since its inception. Somewhere along the line, this is going to level off—but color TV will enable it to take off again. It will be like a new industry."

"Right now we're experiencing something like when television first started", adds Stan Hubbard, Jr. (Manager KSTP Radio). People are gathering in homes of color set owners to watch the programs. And the distributor does not have enough sets to take care of the demand."

"Color sets are now much simplified",

FIG. 5. T-N-Tatters is a 40-minute circus show for children put on live in color. It runs daily from 4:35 to 5:15 p.m. An audience of 50 to 100 happy youngsters is usually present. Daryl Laub is T-N-Tatters, the clown.

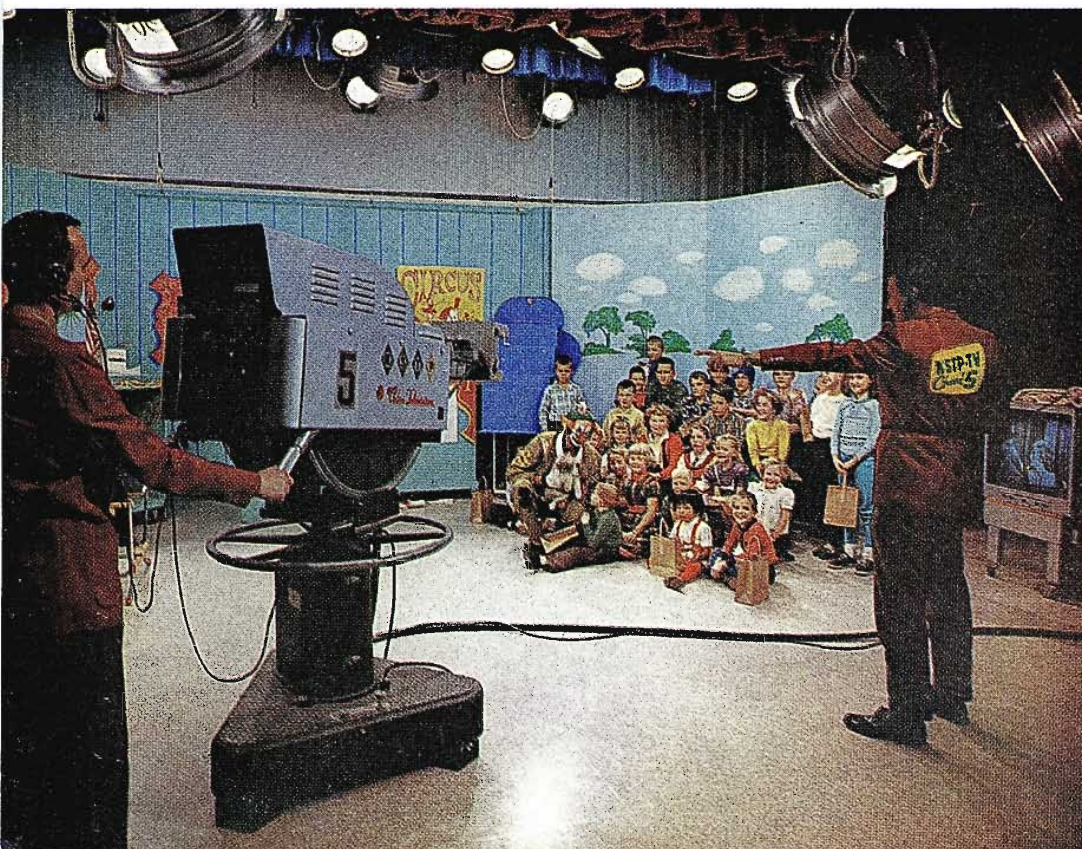

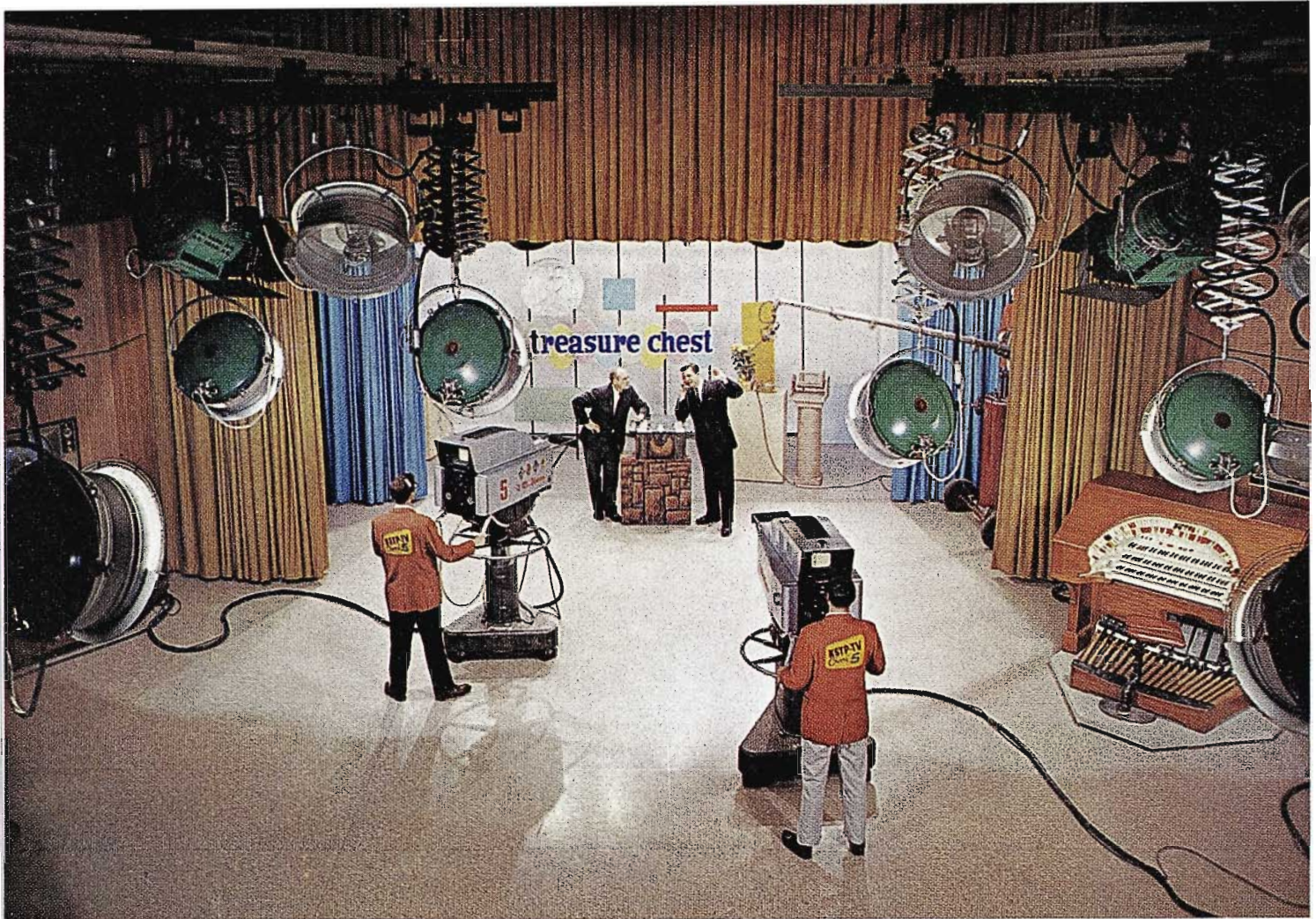

FIG. 6. Treasure Chest is a 40-minute audience participating adult ladies show put on live in color. It runs daily from 12:20 to 1 p.m. Prizes are given to contestants. (This view shows stage section of new color studio.)

reflects Stan Hubbard, Sr., "they're neither difficult to adjust nor expensive. The picture is graphic—very colorful.

"We have a multi-million dollar investment in KSTP-TV. We plough back a lot into new buildings and now, into color facilities. We're taking part in the big push."

Color Programming

KSTP is now programming several local live color shows daily. On Sunday night, there is an hour long drama colorcast. Specials are put on in color whenever the occasion warrants.

Daily color programs include: "Treasure Chest" for the ladies, "T-N-Tatters" for the children, and News shows for all ages. In addition, there is a weekly religious program in color "Quiz a Catholic."

Color film processing facilities have been added so that the station can present daily happenings of significance as they actually appear to the eye. Several color News showings are put on daily—as fast as color film clips are received and processed.

All of the foregoing is in addition to the massive NBC schedule of color programs. All of these are carried by KSTP. This means that viewers in the Twin Cities

area have a chance of six to seven hours of color in their daily TV fare.

Color Brings Revenue

Surveys show that color shows attract more viewers and experience reveals that color commercials cost somewhat more to produce than monochrome. As a result

KSTP makes an additional charge for color.

Station KSTP has very complete color facilities for producing TV shows and commercials, both in the studio and remote locations. Two studios are used for color and each has 2 TK-41 live color cameras.

FIG. 7. Color specials are frequently put on, especially during the holiday season. Six specials in color were programmed during the 1961 Christmas season. This view is typical of the colorful sequences seen by KSTP audiences.





FIG. 8. Setting up of typical color commercial in KSTP new color studio.

A Color TV film system is equipped with TK-26 Color Film Camera, two TP-6 16mm Projectors and a TP-7 Slide Projector. In the tape area, there are three RCA color TV Tape Recorders, Type TRT-1B. Color programs and commercials can be put on live or via TV tape.

The photo news department is equipped for color operation. Motion picture cam-

eras are loaded with high speed 16mm color film. Exposed film is rushed back to the station for fast processing. KSTP has its own complete color processing facilities so that color shots can be aired very soon after shooting.

These complete color facilities for live, tape, and film telecasts are probably among the finest of any station in the nation.

FIG. 9. One of two master production control rooms. These are equipped with TS-40 Transistorized Switching and RCA Special Effects Systems. They can handle both color and monochrome programs.



Four Studios

KSTP has four fully operative TV studios, three of which are equipped for rear screen projection and three are equipped for color TV productions. Studio No. 1 (24 by 41 feet), equipped with two TK-11 Cameras, is frequently used for sports and for taping of black and white programs.

Studio No. 2 (formerly the main studio) 51 by 60 feet, is equipped with two TK-11 Cameras and two TK-41 Color Cameras. Its concrete block walls from the 4-ft. height to the ceiling are covered with rock-wool padding. The ceiling is covered with acoustical tile. The concrete floor is extremely smooth as well as level. Approximately one-fourth of the wall area is covered by a cyclorama. There is space for many portable sets: News, Weather, Commercials. Directly outside this studio is a parking lot for live demonstrations of heavy equipment.

Studio No. 3, 40 by 60 feet, is the new main studio, especially designed for stage shows, audience participations, and large musicals. It has excellent facilities for color lighting and acoustics. It has a terrazzo floor, so super-smooth that live cameras can be dollied with no noticeable effect on a telephoto lens. Its provision for flying curtains and scenery, for professional stage presentations are unsurpassed.

Studio No. 4 (24 by 46 feet) is a floating-studio designed for special musical productions and also serves in an emergency for other shows and commercial presentations.

The first three studios are on ground level and will accommodate drive-in vehicles. All studios have client observation mezzanines. Available also is a large lawn patio for outdoor telecasting under studio conditions. Two 35-foot remote cruisers, equipped for monochrome and color furnish TV facilities away from studio location.

Studio Control Rooms

All studios may be operated from either of two production clusters. Each cluster consists of control room and associated announce booth. Each control room is identically equipped with audio control, TS-40 Transistorized TV Switcher, and Special Effects system. The switcher panels used in control rooms are identical with those in master control. This means that operations are simplified, easier to understand, and there is less chance for error.

Announce Booths

Each announce booth is adjacent to the control room. Each booth contains a twin 8-inch monitor—one monitor for transmitter programs, the other a selectable preview monitor. There is a panel containing microphone on-off switch, headphone jacks, and monitor selection. Another panel contains the house intercom system.

New Color Studio

The need for proper sound reproduction of audience shows, choral groups, dramatic productions and pipe organ could not be satisfied within the existing studios. The new studio had to be designed "Live"—acoustically suitable for these reproductions. It also had to accommodate closed circuit viewing for local branches of firms using a national hookup. In keeping with this flexibility of use, the studio was designed for theatrical impressions of live shows, using flown curtaining and props. Furthermore, it was designed for color television.

The new studio is arranged for use as a typical TV studio, or the audience type. One-fourth of the area is used as a stage, under a fly loft 29 feet high. All props and scenery can be flown if required for any particular show.



The side walls are of walnut panelling enabling their use as backdrops for commercials, announcements, etc., that may be part of stage productions. Mr. Hubbard engaged the acoustical consulting firm of Bolt, Beranek and Newman to assist in shaping the studio for directional use (audience shows) or omnidirectional such

FIG. 10. KSTP's TV directors: (l. to r.) Kenn Barry, director of television, Jim Nelson, Bob Sears, Bill Garin, Earl Niemi, Dick Larson, Ed Kindt, and Jerome Wasley.

FIG. 11. Note that operator in production control room No. 3 can see into studio No. 3 (left) as well as into studio No. 2 (right).

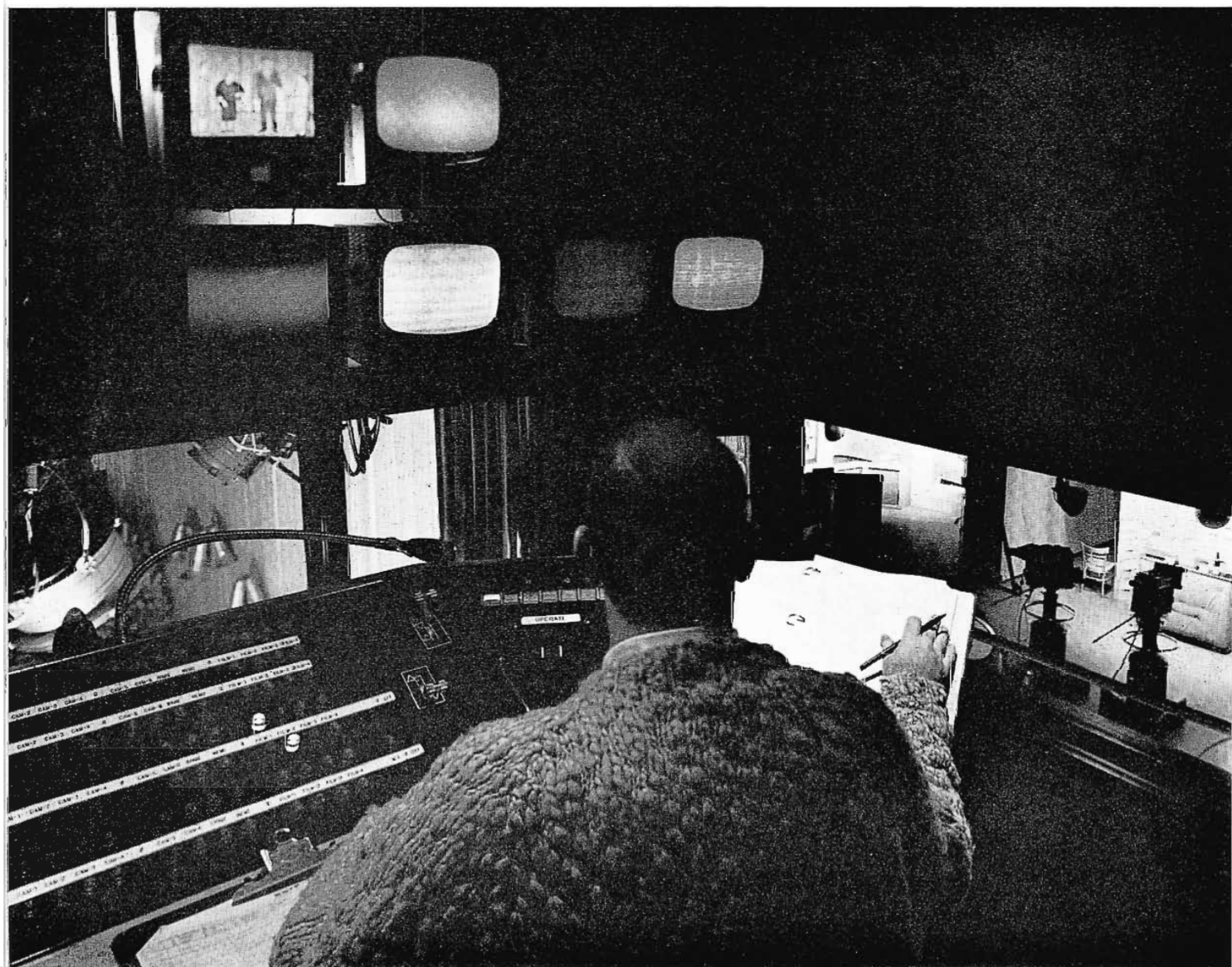
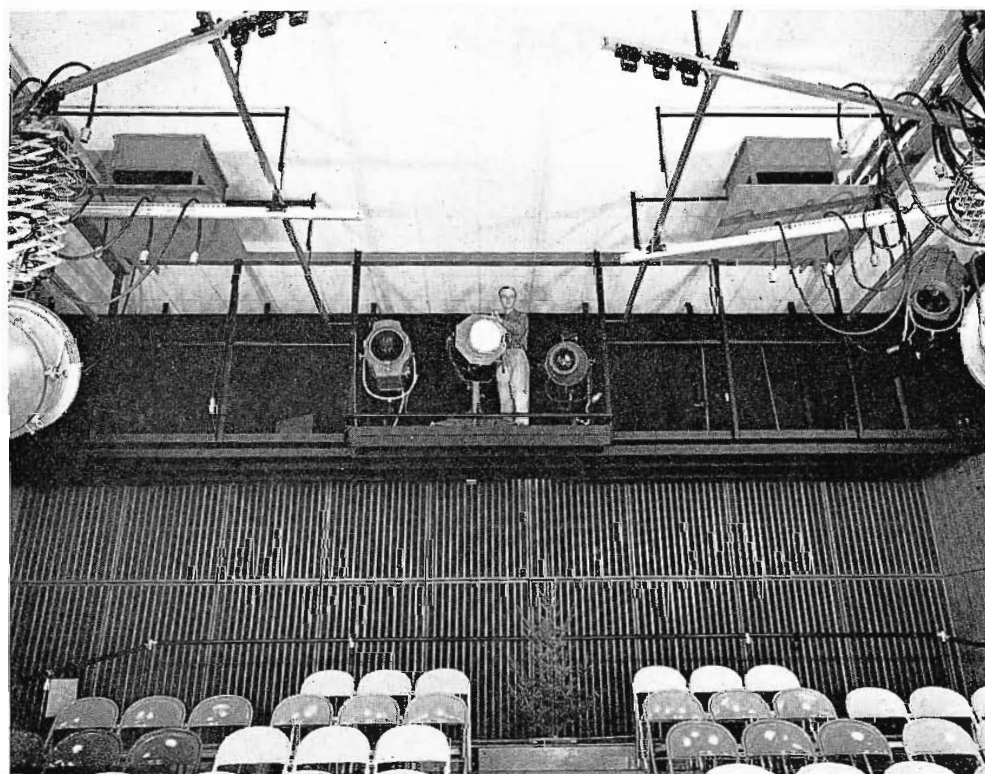



FIG. 12. Stage section of Studio 3. Overhead a.e. motor driven lighting battens. Also rails for flying of scenery and props.

FIG. 13. Audience end of Studio 3. Catwalk at rear can be used to support color TV camera as well as follow-spots and dimmers.



as the choral and musical groups. Color monitors are recessed in the splayed side walls enabling the audience (or closed circuit viewers) to see within a maximum distance of 20 feet from the monitor.

Of special interest is a small snack bar located behind a sidewall panel that silently raises out of sight, opening the bar to the studio for use at sales meetings, conventions, or demonstrations.

Acts as Auditorium Studio

This new studio serves groups of 400 people, has the most modern stage facilities. A lighting balcony with follow-spots and dimmer facilities, plus scenery that can be set up for progressive action without breaks for background changes, provide a continuous program period that may be viewed on the color monitors built into the wall. The studio is completely equipped for color telecasts, has complete dressing room facilities, built-in kitchen with equipment for serving studio audiences.

Color Studio Lighting

The new color studio lighting has been designed by a Hollywood consultant. Thirteen 5kw Sky Pans form the basic overhead studio lighting. These are mounted on pantagraphs supported from a Century Mobilrail system. This arrangement permits movement in all directions as well as up and down. The Sky Pans supply 200 kw of lighting—more than sufficient for the largest of color shows—lighting both the sets and the audiences. A total of 36 circuits are used, 12 of which are on dimmers.

The staging area is equipped with four motorized light rails and two motorized curtains. There also are hand-operated rails for flying scenery and props.

Studio Air Conditioning

To maintain rigid acoustical requirements, sound attenuators were used in the duct systems and specially designed air diffusers were installed to control air noise level and to control high room air turbulence without velocities that would move sets, flies, curtains, or performer's hair and costumes. As the air temperature rises in the fly loft portions of the studio, an exhaust fan is started to eliminate any excessive heat conditions. Normal use calls for 50 per cent fresh air. Whenever the outside temperatures are below 44 F, it is possible to cool the studio without the use of chilled air. The offices and the new building achieve outstanding dust control by use of Precipitron electrostatic air filters.

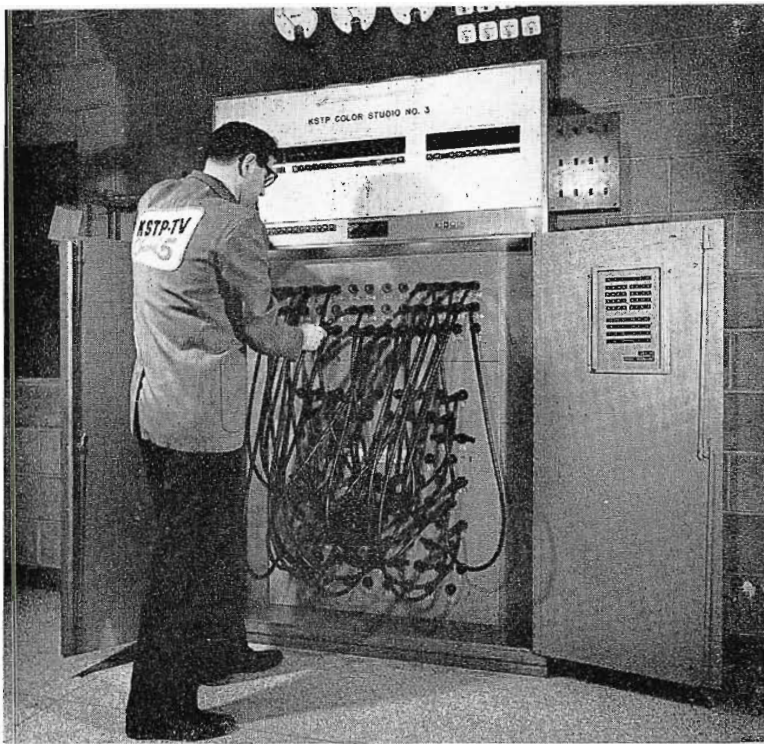

FIG. 14. (left) Three meters at top are load current indicators for the 3 phases on the 24 non-dim 50-amp circuits. Group of 12 meters and outboard panel are metering and control for 12 dimmer 50-amp circuits. All dim and non-dim circuits appear at top part of patch panel, while the 85 load circuits appear in lower part.

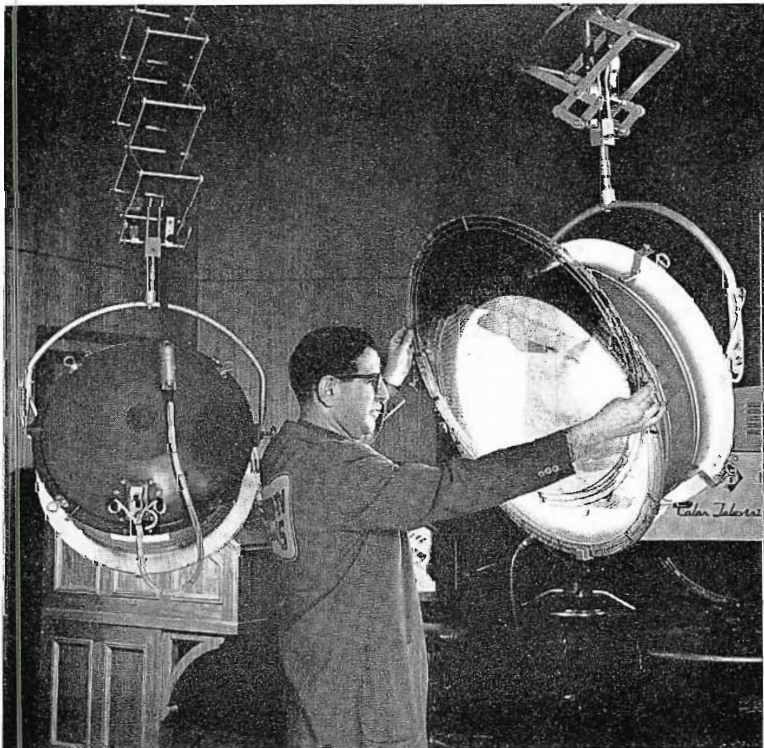

FIG. 17. Mobile rail system is employed for supporting and positioning of lighting fixtures. Note air-conditioning diffusers. Also part of ceiling is plastered for "live" acoustical effects.

FIG. 15. (left, below) Pantagraph mounted 5-kw Sky Pan. Joe Reznick is inserting a color gelatin filter.

FIG. 16. Note splayed paneling used in new color Studio 3 for acoustical as well as artistic effect. Also visible is built in color receiver, employed as studio monitor.

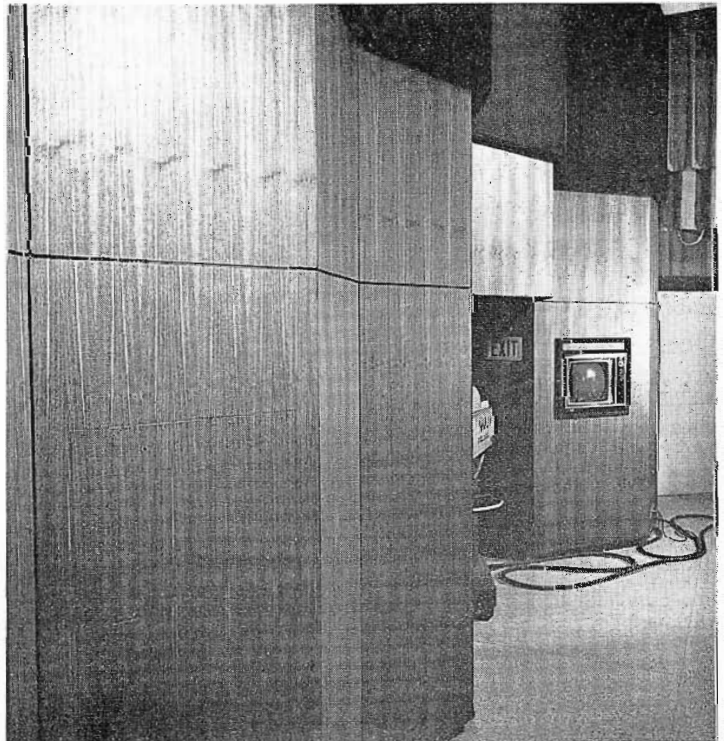
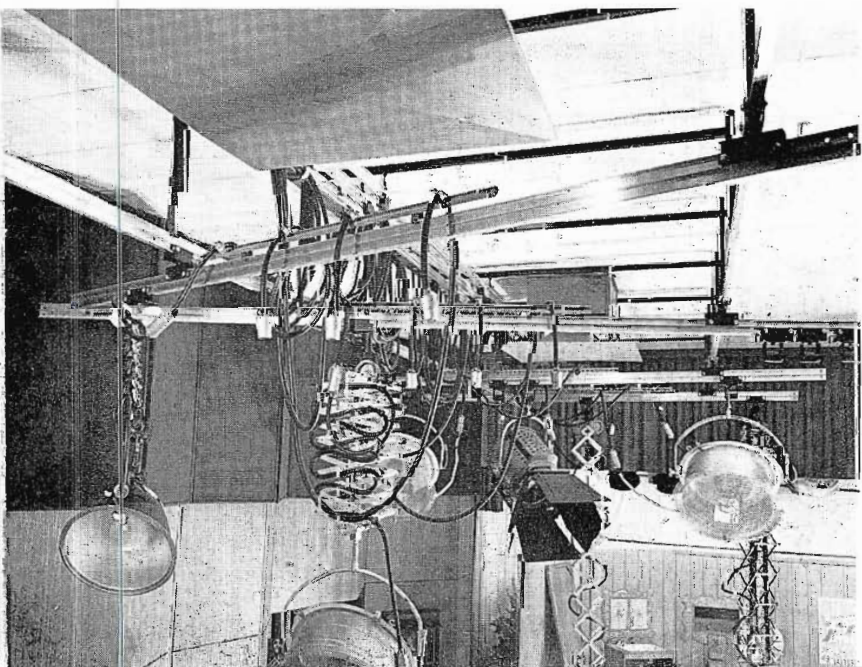
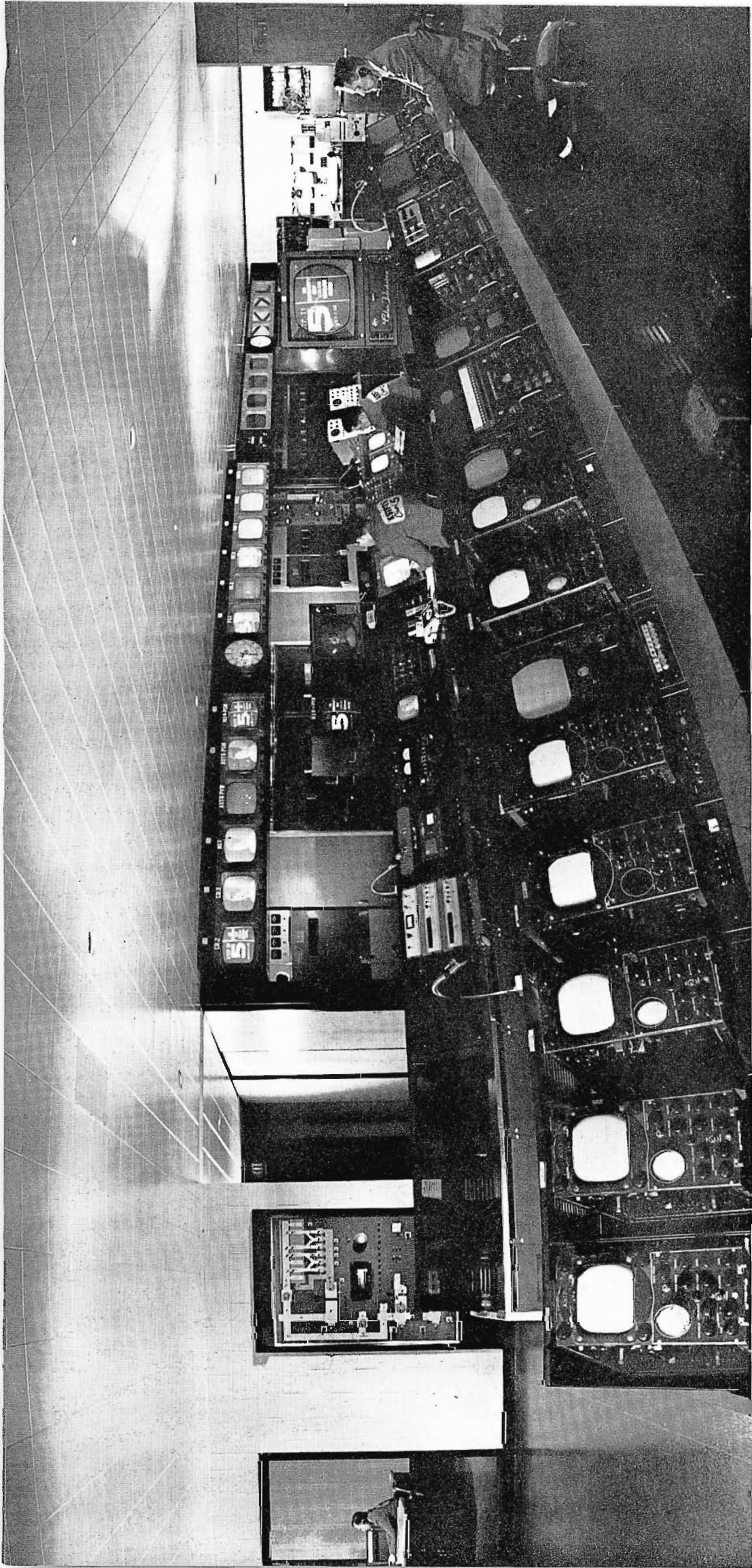

FIG. 18. Engineering brain trust of KSTP. Left to right: George Merrill (holding instruction book), Kess Pool (holding audio amplifier), Dick Elliott (reel of TV tape), John Reinke (transmitting tube), Hugh Mulholland (image orthicon), Fred Debeaubien (holding catalog), and director of engineering operations, Fred Street (extreme right).





Advantages of New Arrangement

There are many advantages to a one-room layout according to KSTP engineers: "There is one set of monitors that all can see from any place in the room. If anything should go wrong, there are always several technicians to help. There are no specialists, many can do the same job, making our men more versatile. It reduces the feeling of isolation, makes people realize one another's problems, contributing greatly to our reliability and overall efficiency."

New switching facilities improve operations and picture quality. As a station grows, demands upon its original equipment often make it necessary to provide auxiliary circuits in order to handle all the requirements placed on the system. This results in long circuit paths, with signals passing through numerous distribution amplifiers, thereby contributing to picture degradation. Through installing of three identical Type TS-40 Transistorized Switching Systems, in two studio control rooms and master control, KSTP has taken steps to preserve picture quality for its viewing audience.

FIG. 19. Overall view master control engineering area. (Made with special 140-degree angle camera. The distortion is very apparent but it gives an interesting panoramic view of the new control area.) Starting from the left; New audio control which is a portion of control room No. 3 cluster, air-conditioning panel, master control console row, and (foreground) camera control console row. In rear, transmitters, monitors; and on the right (not seen) projection and video tape equipment. The man seated to the left at the front console is Bill Jarvi, transmitter engineer; on the right, Don Kline, projectionist; and at the foreground console, Herb Krajewski, video operator.

FIG. 20. (below) Floor plan of central engineering area. Note 15 positions at master control console, and 18 at camera control. (There are no camera control positions in the individual control rooms.) Note that TV Transmitters (main and standby) are in this area, also two film islands, and three TV tape recorders. In addition, all rack and power equipment is located here. This arrangement makes for maximum efficiency.

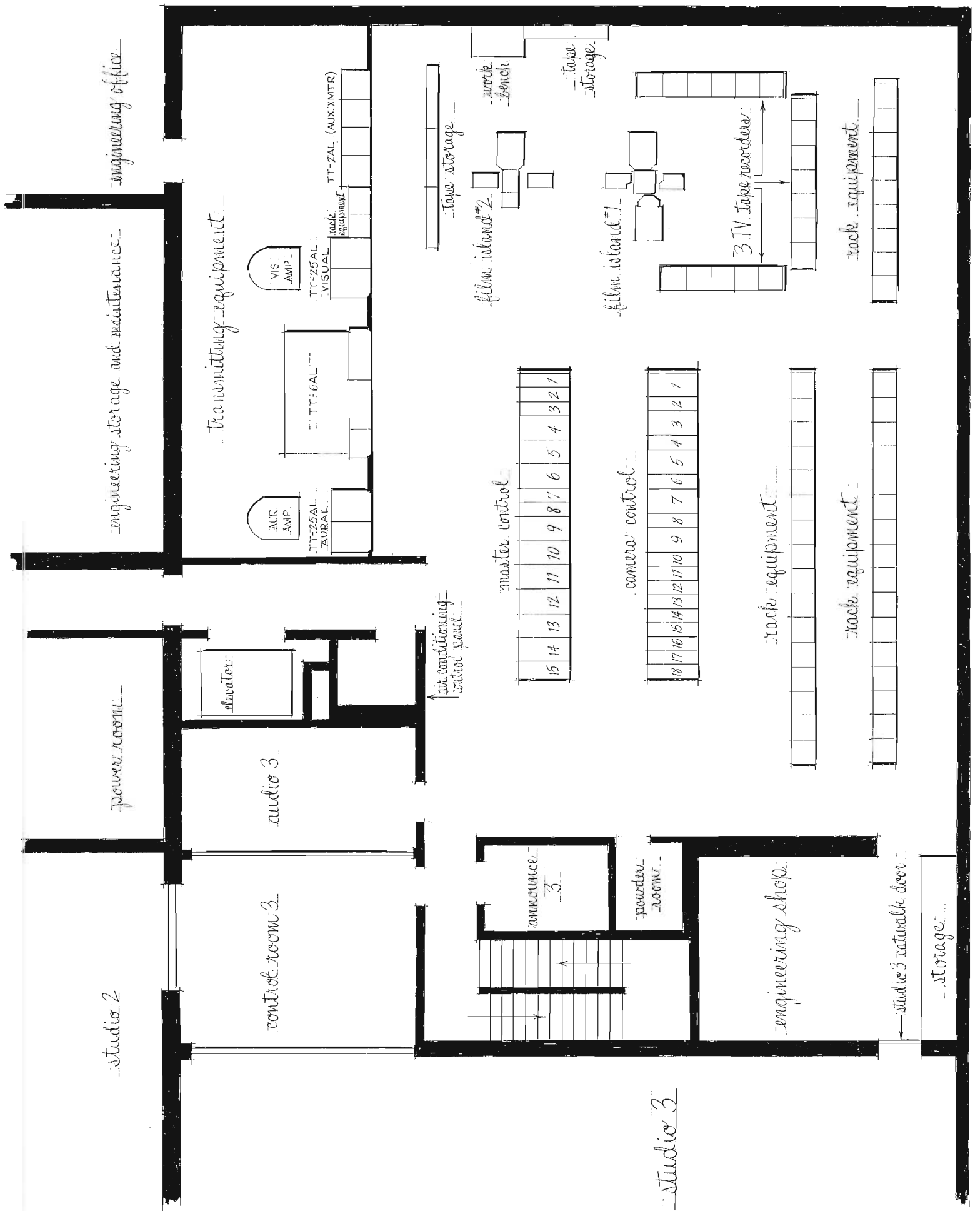

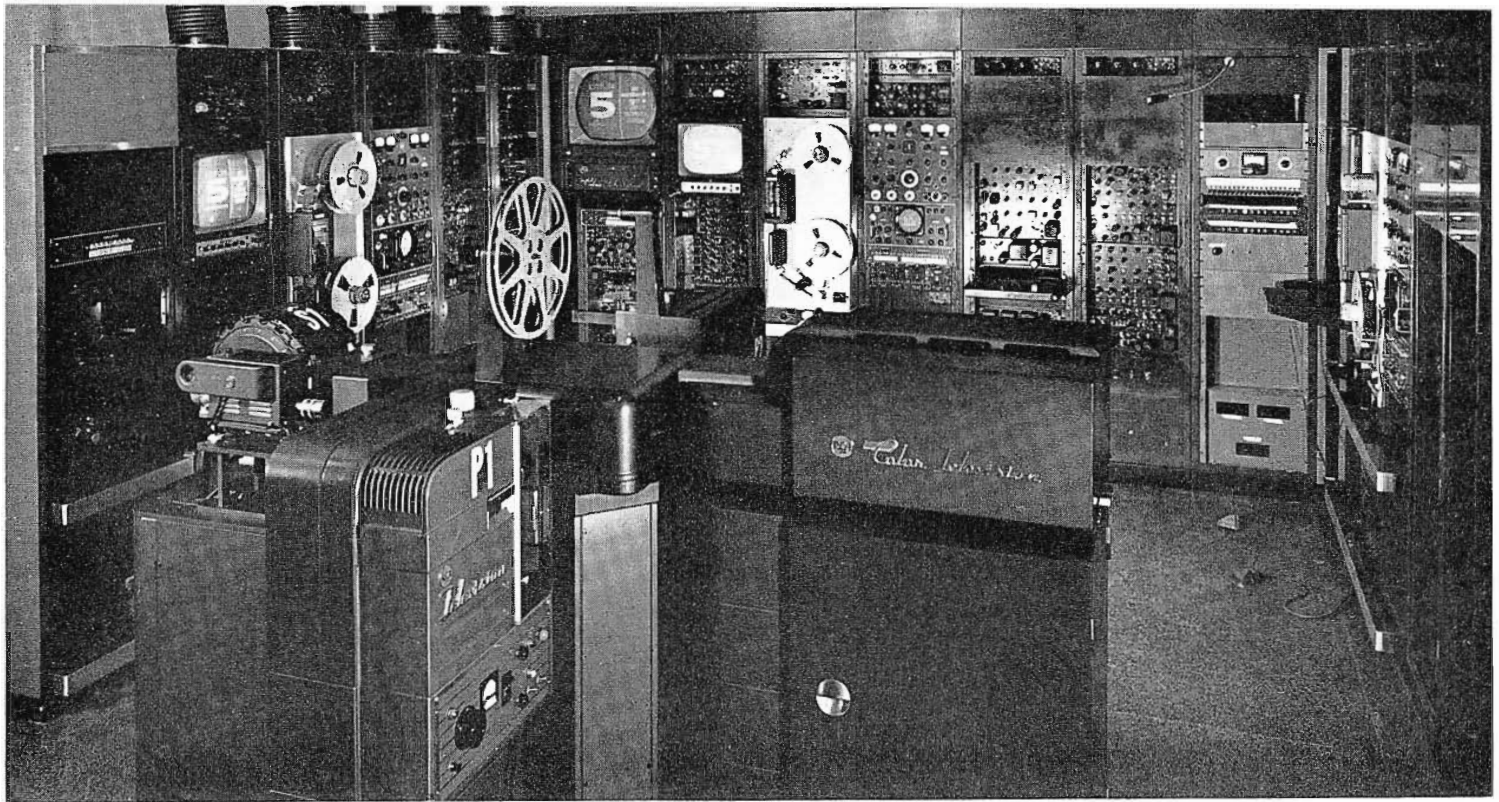

FIG. 21. In foreground is color TV film island. (There is also a monochrome film island.) Three TV Tape recorders are shown in U-shape background. All three are color recorders.

TV Tape

KSTP has a sizeable TV Tape operation. All of the local specials are put on tape in advance of show date. Both color and monochrome shows are taped. These tapes are also used for closed circuit presen-

tations at sales and business meetings. Furthermore, almost all of the local commercials are taped. As a result KSTP has installed three TRT-1B recorders. Since the emphasis is upon color all machines are equipped for color operation.

FIG. 22. Type TT-25CL 25-kw main TV transmitter. Fred Street, director of operations, and Larry Larson, director of research and development. At right TT-2AL 2-kw auxiliary TV transmitter. Coax switches permit either transmitter to be connected to one of two antenna systems.

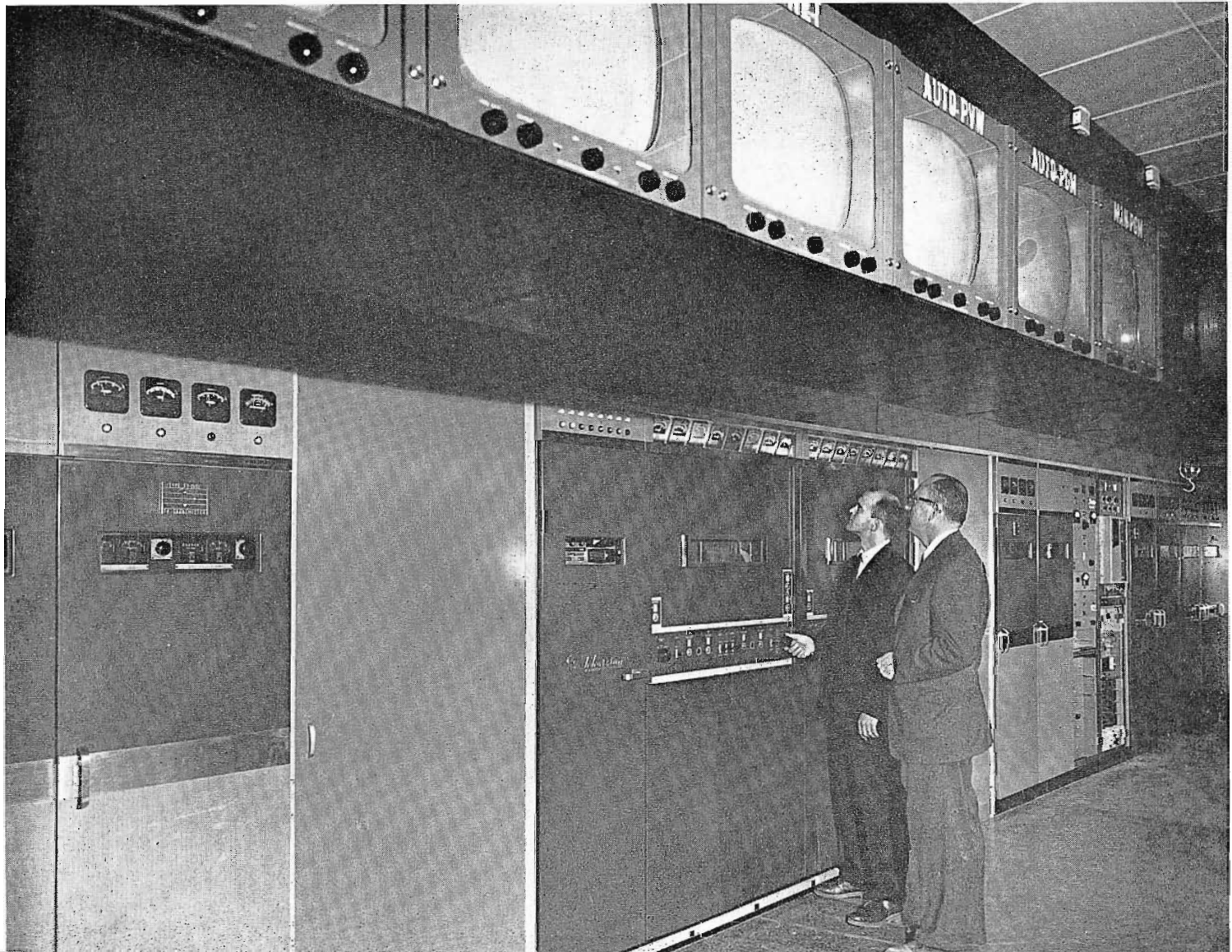



A great deal of editing and splicing is done. It's not unusual to run 20 splices in a half hour show. The Christmas color special, for example, included 50 splices. All of these are made with the regular RCA TV Tape splicer but with a KSTP design mounting bracket—for "sit-down" use.

KSTP has proved the efficiency of installing more than one machine, since with two one can run tape shows back-to-back. They can also insert commercials and other small pieces into programs without having to edit the main tape. It has been found very convenient as well as economical to use separate small reels for individual commercials and announcements rather than edit them in and out of show tapes.

FIG. 23. TV master control. At left in console 1 are two RCA cartridge tape recorder units, one BA-7 recording amplifier. (These along with other equipments are tied into the automation system.) Console 2 houses the antenna and transmitter switching panel for motor driven coaxial switches, Conelrad monitor and weather radar controls.

Console 3 contains remote control panel for the transmitters. Console 4 houses TM-6 transmitter monitor. Console 5 contains remote control for stabilizing amplifiers and sync generator switch-

ing. Console 6 houses the automation readout and control. Clint Barstad, transmitter technician, is reading information into the automation.

Console 7 houses preview monitor and master video switcher. Console 8 houses RCA designed master control audio switching. Console 9 provides remote controls for two film islands and three TV tape recorders. Console 10 and 11 house the controls and waveform monitors for two TK-21 monochrome film cameras. Robert Fries, projectionist, is at these controls.

FIG. 24. Camera control position in new engineering area. At left are controls for all 13 black and white cameras—note power supplies beneath. Don Nordstrom is at the controls. To his right are controls for four studio color cameras and the 3-V color film camera. Hugh Mulhollam, studio working supervisor, is at the controls.

Into these console sections have been built several transistorized headphone stations to permit the video man to occupy several positions as necessary. The trenches underneath the console are tied into the cellular floor, and no trenching extends beyond the limits of the console lineup. Therefore, people rolling chairs or pushing scopes never get them caught in trench plates.





FIG. 25. View of the master control operating position showing master control audio. Bob Winters is at the controls. To his right are multiplexer and TV tape control panels. The audio control system was custom designed by RCA to meet KSTP requirements.



FIG. 26. RCA Cartridge Tape installations at master control. These units are tied into the automation system. Announcements are pre-recorded and started automatically for use with film and slide video. Ray Aula is loading a tape cartridge into the system.

Accommodations for Cables

To accommodate the myriad special power requirements in a modern radio and television station, it was necessary to carefully plan the structure to allocate spaces for a tremendous multiplicity of electric circuits. At KSTP this was done by selecting hollow steel cell members for the floor structure under the engineering and control areas. These cells are fed from below with

open cable racks suspended directly below the floor and running at right angles to it. Practically every cell is provided with a grommeted opening above the cable racks into which cables are pulled as required. These cells carry power feeders, branch circuits, telephone cables, TV camera cables, intercommunication cables, control wires of all sorts and many other wires and cables for special equipment.

Above the cells there is a thick concrete floor, except in certain strategic areas under or adjacent to electronic racks, transmitters, control consoles, etc. where the steel floor is left exposed to form large raceways. The floors of these raceways have 4-inch grommeted openings into each cell for pulling in and terminating all of the various cables described above. The cable racks, trenches and cells are all provided with a

FIG. 27. Ray Aula, transmitter technician, entering information in memory of automation equipment. The system accommodates 12 events. These can be previewed at any time prior to air time. Each event is triggered by a master clock. (Note telephone speaker-microphone system atop console.)

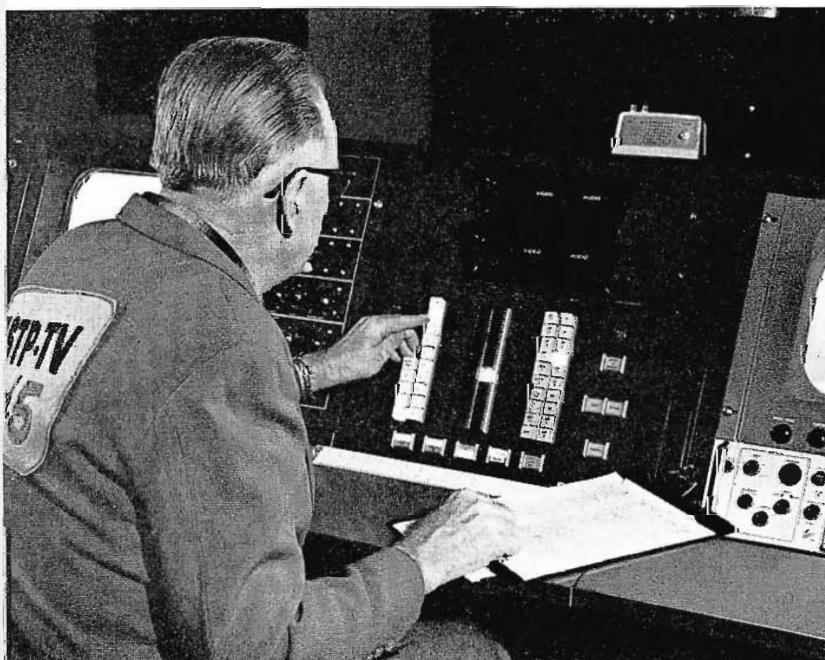

FIG. 28. Rack equipment for automation system is designed for convenient installation and ease of maintenance. Three double sided units are mounted on rollers, making every component and connection conveniently available for testing and servicing. John Reinke, technician, demonstrates sliding action.

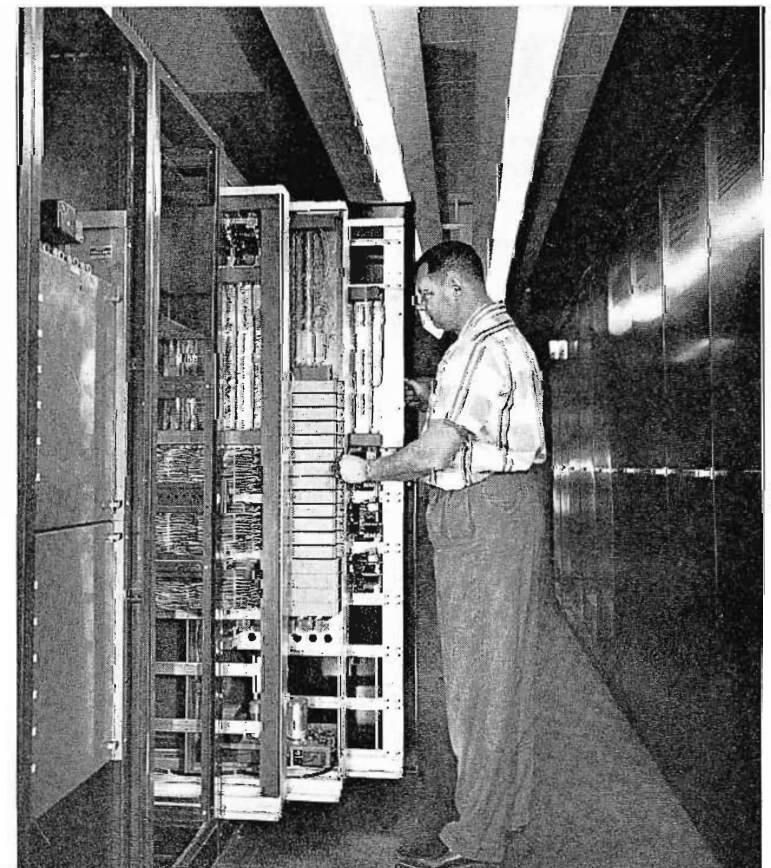



FIG. 29. Don Benedict pulling wire into trenching system. Trenches are under transmitter, consoles, and all racks. All run north and south and are 6 inches deep and 18 inches wide. Since area is designed with cellular metal flooring, cross access trenches are not necessary. Four-inch diameter holes (foreground) lead from trenches into cellular flooring and wires can be pulled down through these holes up into the selected trench.

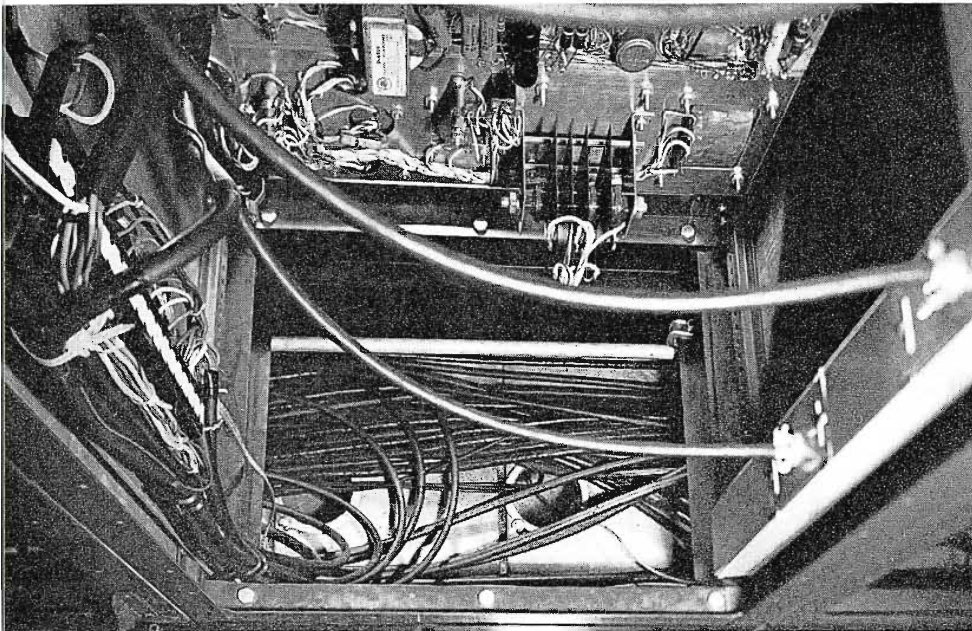
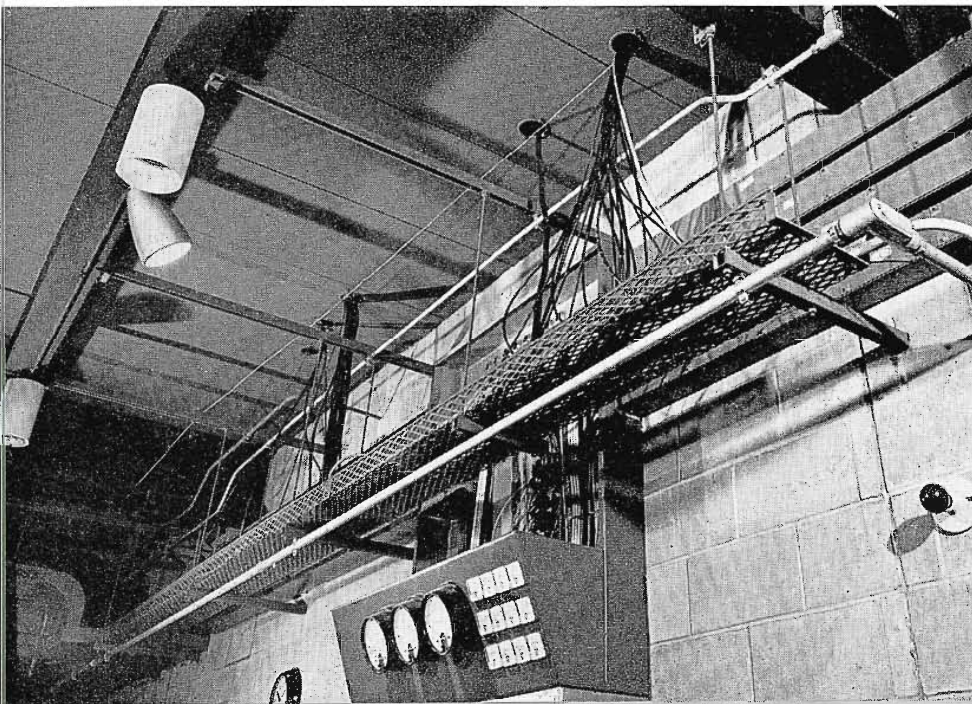

FIG. 30. At base of this rack note metal cellular flooring thru which cables enter trenches.

FIG. 31. A view of the basket construction used beneath the cellular floor in the engineering area to transport cables to other portions of the building.



continuous copper grounding strap which is bonded to an underground grid and to the steel structure of the building.

This system provides the greatest possible flexibility and it is easy to relocate or add cables at any time; even the color camera cables can be pulled in place without removing the terminal plugs. Up to this time roughly only 30 per cent of the cell and cable rack space has been used so that any likely future expansion is provided for.

Conditioning Technical Area

In main engineering, a point of special interest, is that perforated metal pan tile are used with approximately 35 per cent of the tile having acoustical pads laid irregularly throughout the area to achieve both sound and air flow control. It is possible to "spot cool" or "spot sound control" specific areas in this manner. It is flexible to changes, since the metal ceiling tile are easily removable, and high temperature differentials can be used without creating conditions outside the human comfort zone.

The transmitter equipment portion of the new engineering area is served by a system of duplex units, all controlled at the electronic panel. The main air supply is a low-pressure slow-speed fan supplying 9600 CFM of climate-controlled air directly to the space and to a supply plenum which feeds air to three amplifier and three transmitter high pressure fans. A return air fan either feeds this air back into the

FIG. 32. John Reinke using air connection at end bell of rack section. These air outlets provide air from 2 to 100 pounds through a regulator to simplify cleaning of the rack equipment. . . . Also shown is part of relay bank of production intercom system. This provides 20 stations which can be operated in two ways: Individual selection, unit to unit; or public address selection. Up to 19 stations can be tied together and operated by a master switch.

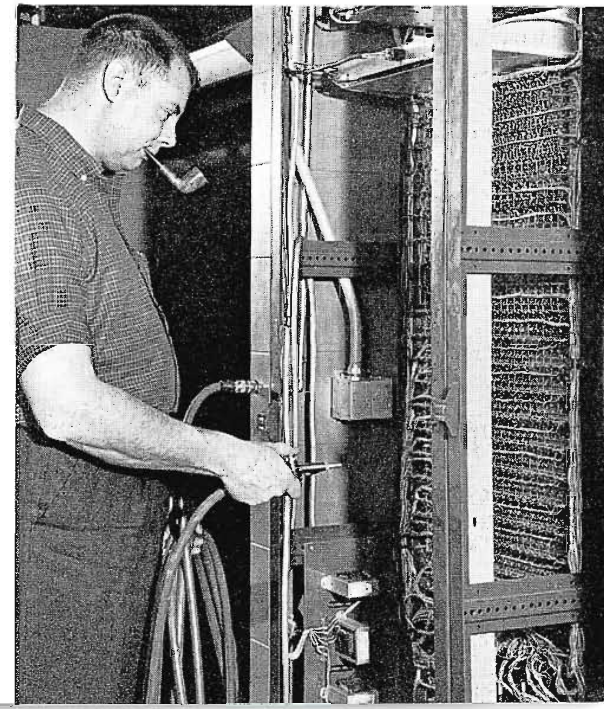



FIG. 33. Clint Barstad and John Reinke, KSTP technicians, at the first row of racks in TV master control. These racks are designated by No. 1 on the far left and ending up with No. 16 on the far right, with No. 16 containing the power distribution. Along the base of all racks power outlets are provided for scopes, voltmeters, tube checkers, etc.

system if heating is required, or it is exhausted to atmosphere as additional fresh air is called for, or it can be fed by a special switch into the main engineering fan system to provide a means of supplying heat during an emergency boiler plant shut-down.

Special air flow switches in the air supply trunks to the amplifiers and transmitters serve as actuators to flashing signal lights and an alarm horn at the electronic panel. Then engineering technicians can switch to one of the two emergency fan systems with a delay of only seconds.

Certain exterior zones have a floor radiant panel at the perimeter edge controlled by a specially mounted thermostat to sense the outer wall skin temperature. Main public entrance outer walks have snow melting panels to keep walks clean and dry during the heavy Minnesota snowfalls.

FIG. 34. TS-40 Switching Arrangement. On far left is master control TS-40. Next is TS-40 switcher and TG-25 special effects generator for control room 3. Right rack is TS-40 for control room 2. Note air exhaust ducts at top of racks.

FIG. 35. George Merrill, transmitter supervisor, at air conditioning control panel. Three separate air conditioning systems are controlled from this panel. The top section controls transmitter and transmitter room. Colored lights indicate which blowers are operating and give warning of over temperatures. Temperatures of all critical transmitter points may be read on this control board.

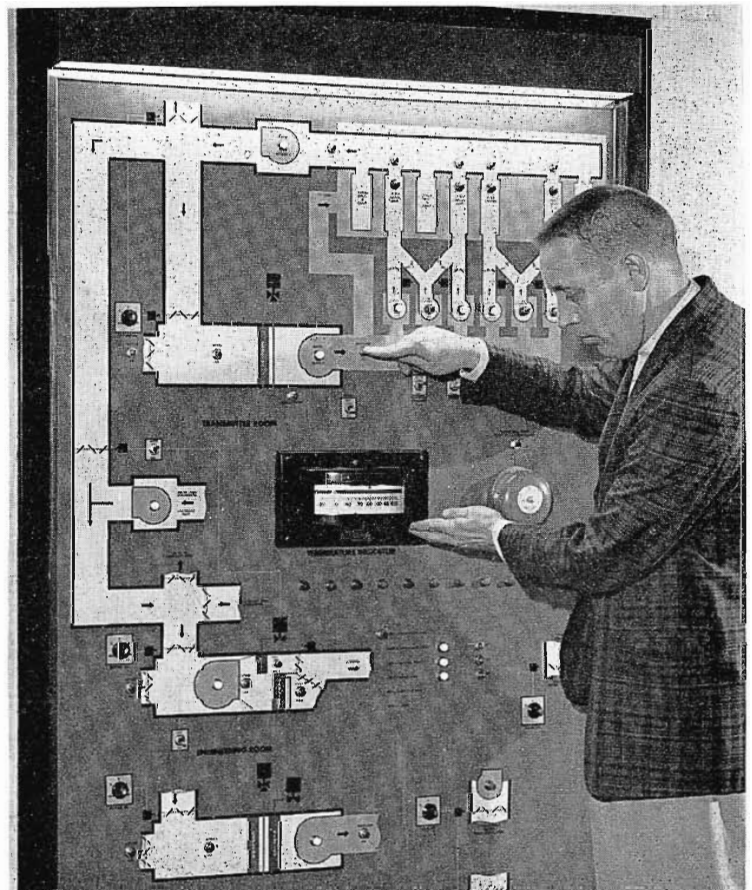
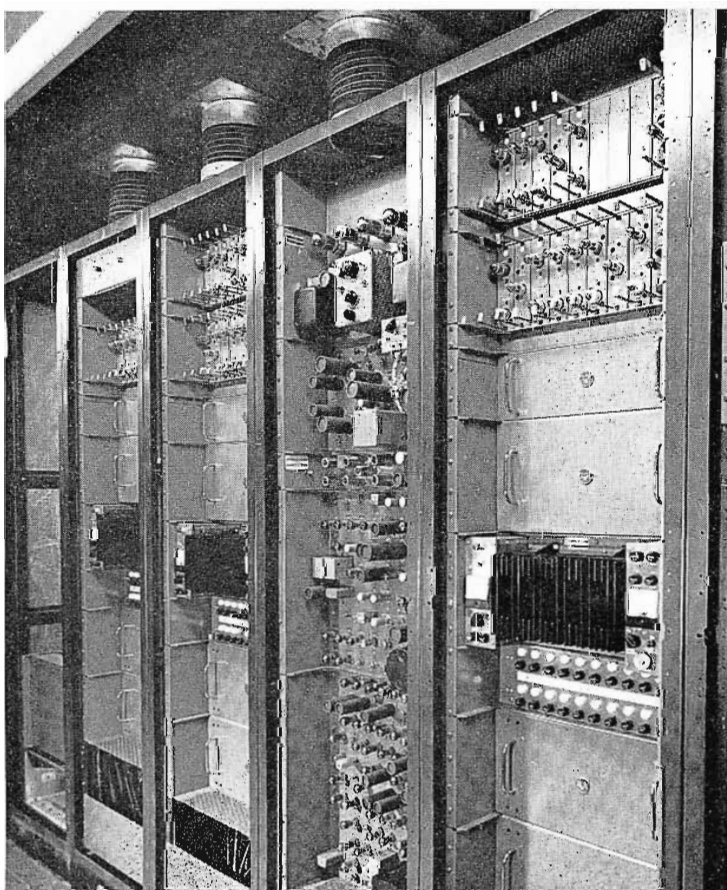

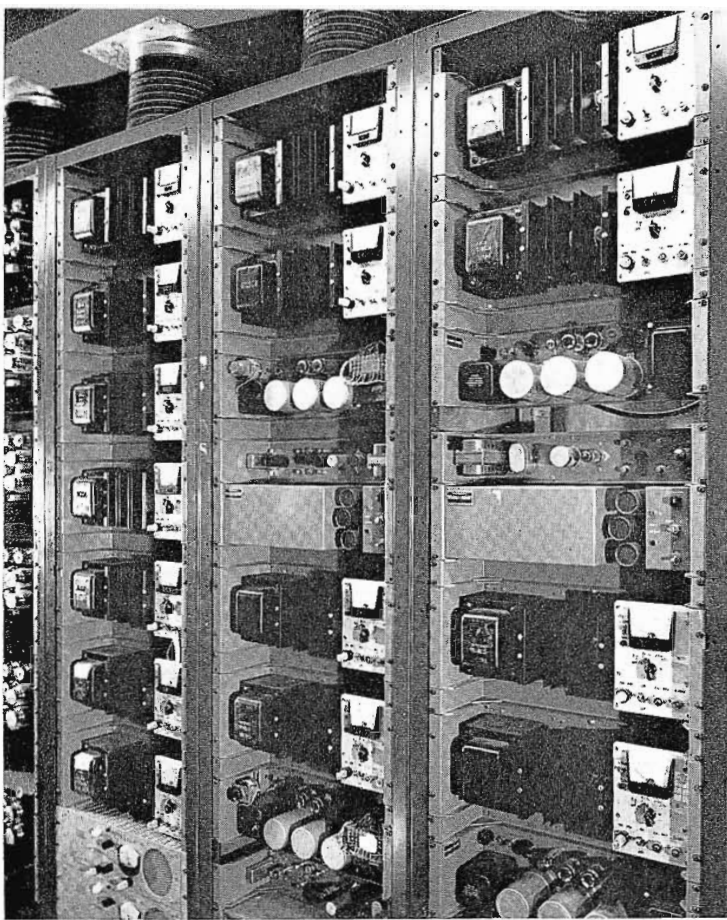

FIG. 36. Power racks showing 15 WP-16 solid-state power supplies for color cameras, terminal equipment, switchers, etc. The low heat dissipation of these power supplies permits loading up a rack with power without worrying about overheating.

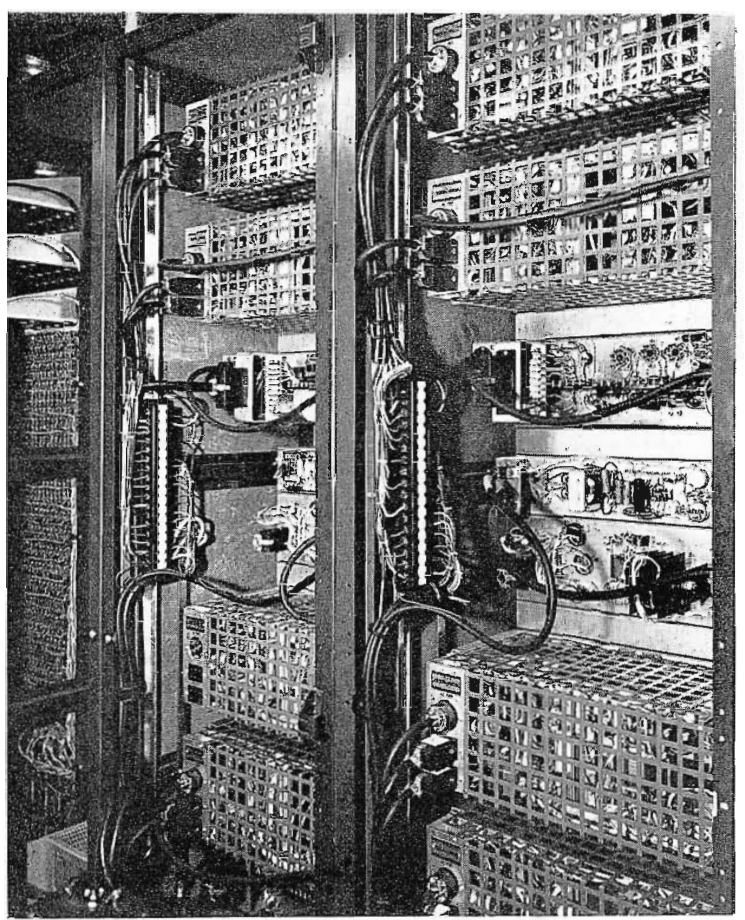

FIG. 37. Backs of racks in power supply section. Note on left of each rack a large terminal block. These provide power distribution to the various services. These blocks are sectionalized and individual sections can be taken out or replaced at a moment's notice.

Negative Ionization

KSTP is probably the world's finest installation generating negatively ionized air to hold down dust; with the expected results being a healthier climate condition for employees and less maintenance for

equipment. A low incidence of infections due to dust repellant from the respiratory systems help promote health. A more sanitary climate condition results because surfaces repel dust particles. Negative ionization eliminates most of the dust and foreign

particles which are a constant problem in attempting to achieve high grade tape quality. It is reported that the spirits of announcers and general attitude of employees are improved significantly by use of negatively ionized air!

FIG. 38. Top of power supply racks. All A-C wiring for racks is carried overhead in 4-inch square ducts and is then carried downward inside the rack in wire mold to insure complete separation of power, video, and audio wiring.

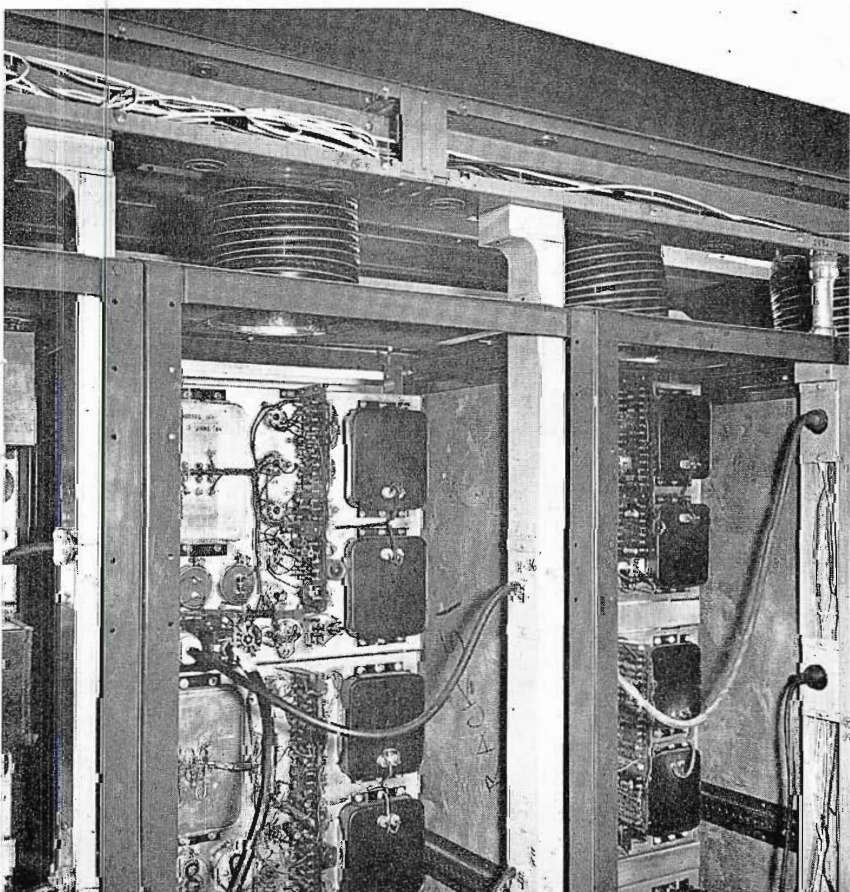

FIG. 39. Stan Hubbard, owner of KSTP (left) and Walt Varnum of RCA. Mr. Varnum made a system study of requirements in conjunction with KSTP engineering staff that led to the design of the new unique KSTP studio building and master control equipment area.

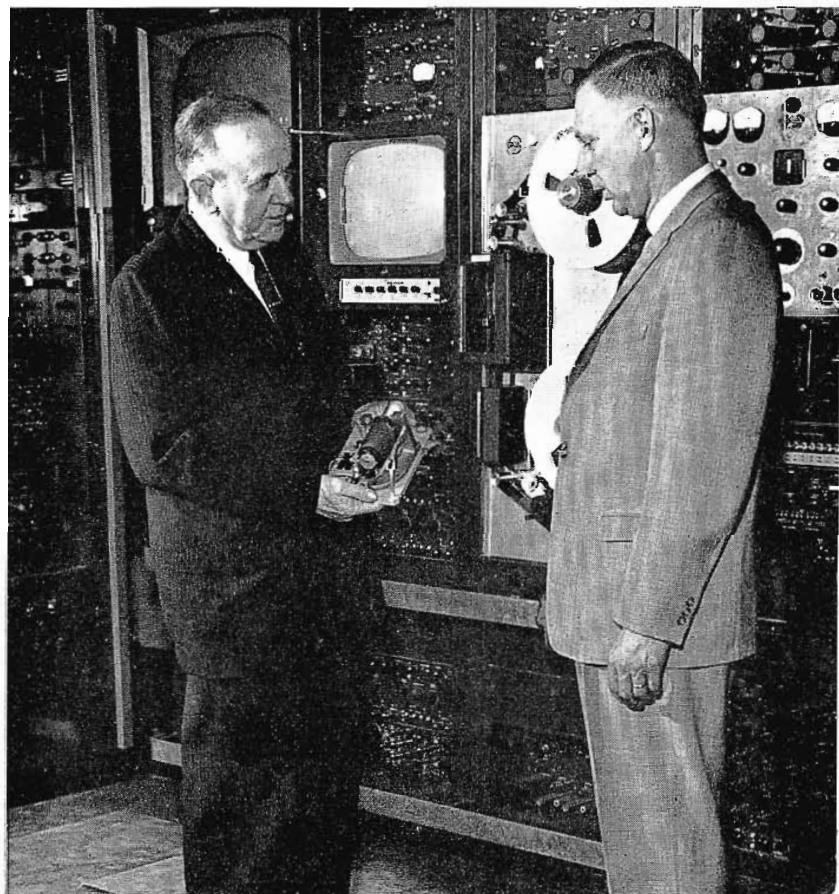



FIG. 40. Don Kline, projectionist, at Film Island No. 1 which includes two TP-6 16mm projectors and a TP-7 slide projector. Also TK-26 Color Film Camera, TP-15 Multiplexer, and TK-21 B & W Film Camera.

Film Facilities

Two complete film islands are installed at KSTP. One is completely monochrome while the other can be both color and monochrome. Each is equipped with two 16mm S.O.F. projectors and 2 by 2 slide

projectors. These film islands are so arranged that they may be assigned to either of the two production clusters.

Included in support of film facilities are monochrome and color processing for stills and movies, comprehensive film li-

brary, and kinescope recording system. There is also a Film Makeup Department with complete equipment for editing syndicated shows and feature films. It is here that film commercials are inserted into film programs.

FIG. 41. Dick Elliott at "sit down" splicer position designed by KSTP staff. This features a special mounting bracket. It makes splicing easier.

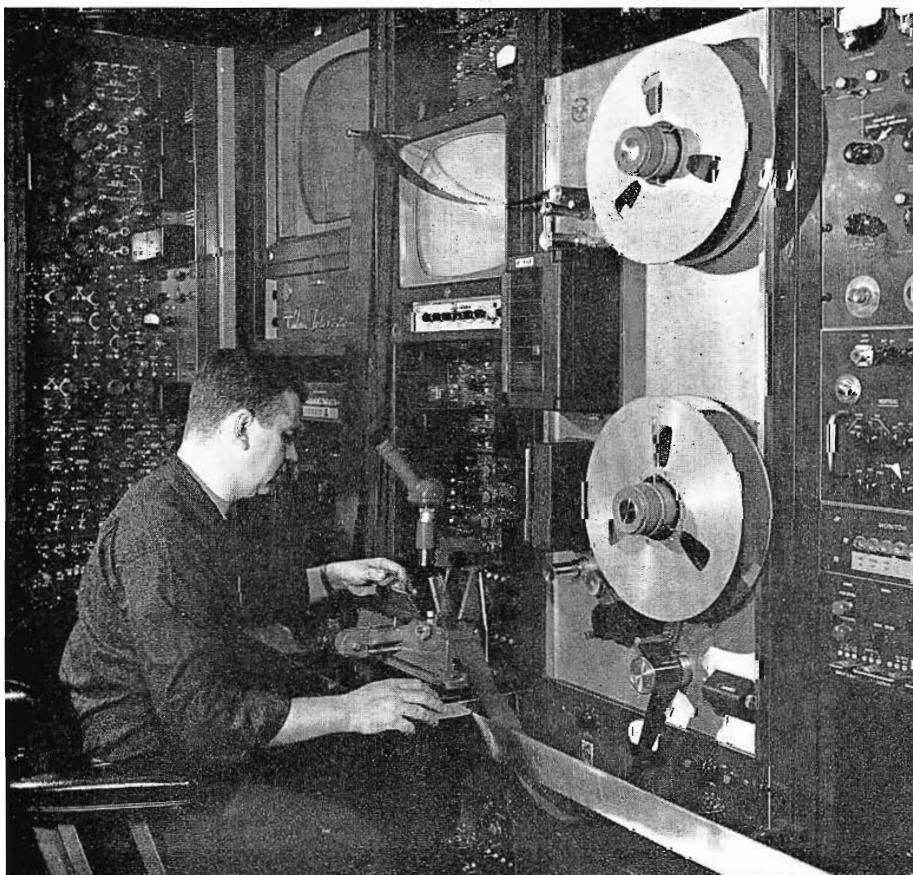
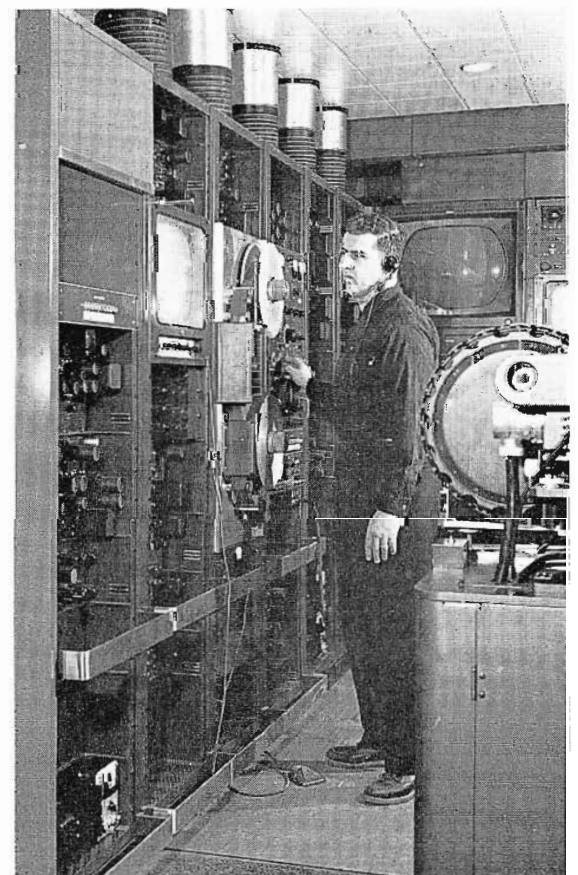

FIG. 42. KSTP has three color TV Tape Recorders—all type TRT-1B. Note exhaust ducts at top.



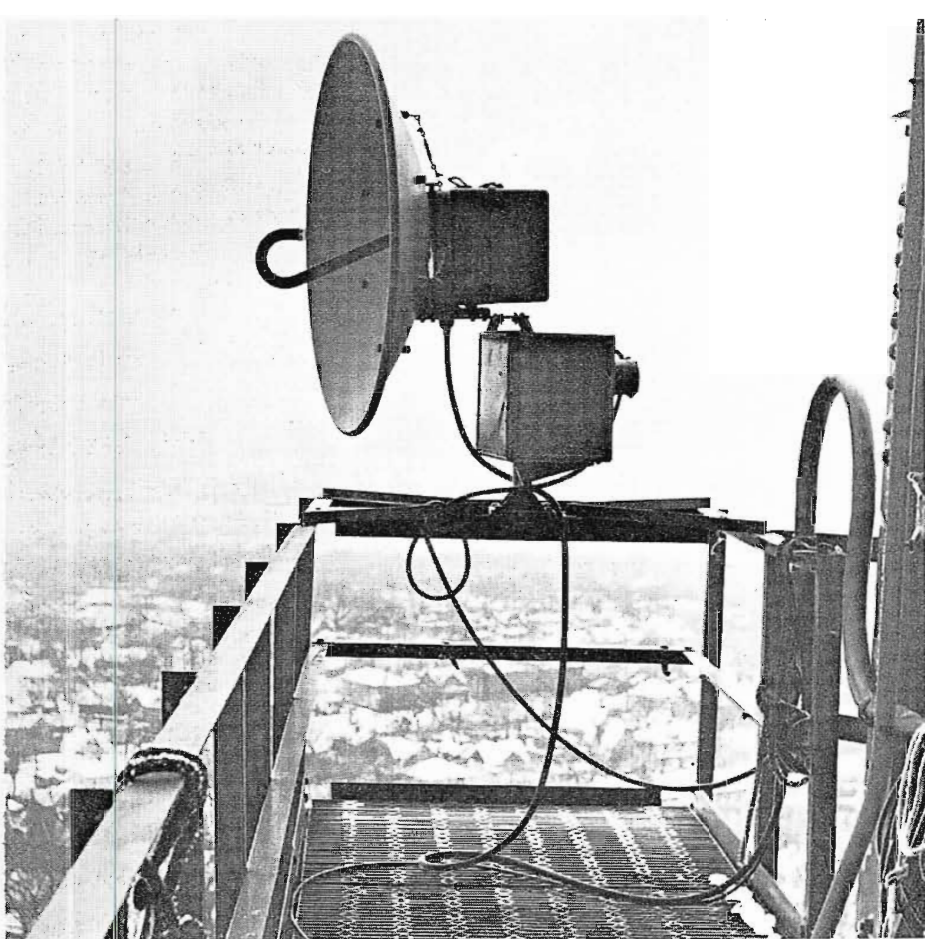

FIG. 43. Tower-mounted microwave receiver and parabola at KSTP for link with remote cruiser. Note remote positioning unit for aligning parabola.

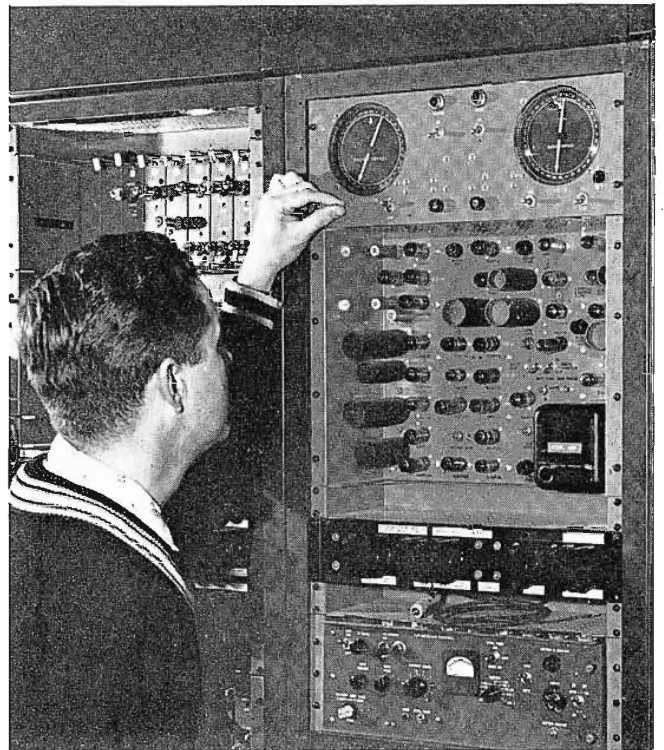

FIG. 44. Transmitter technician, Clint Barstad, adjusting elevation control of parabola on 250-foot level of tower. Control at right is used for azimuth.

Local Microwave Link

A number of KSTP specials are put on tape via the remote cruiser which relays the program to the studio via a microwave link. This is a TVM-1B system designed to handle both color and monochrome. The transmitter of this system is installed in a remote TV cruiser. The studio terminal features a remote controlled parabola installed at the 250-foot level of the KSTP

tower. Direction and tilt of this antenna can be controlled from the TV engineering area.

Inter-State System

Station KSTP is the originating point for a 9-hop microwave system feeding NBC programs to stations KCMT in Alexandria, Miss., and WDAY in Fargo, N. D. This is a TVM-1B system capable of handling both color and monochrome. Five hops,

from Alexandria to Fargo, are reversible for exchange of programs between KCMT and WDAY. Fault reporting, for any of nine faults, is included in the 5-hop Alexandria-Fargo section. (Subcarrier on system operates fault reporting and reversing.) The system also features remote switching to an off-air pickup for another network at a point two hops from St. Paul-Minneapolis.

FIG. 45. Transmitting antenna for 9-hop WDAY microwave installation. Inspecting installation is S. D. Rasmussen, chief engineer, WDAY.



FIG. 46. Passive reflector is mounted at 250-foot level of KSTP tower.

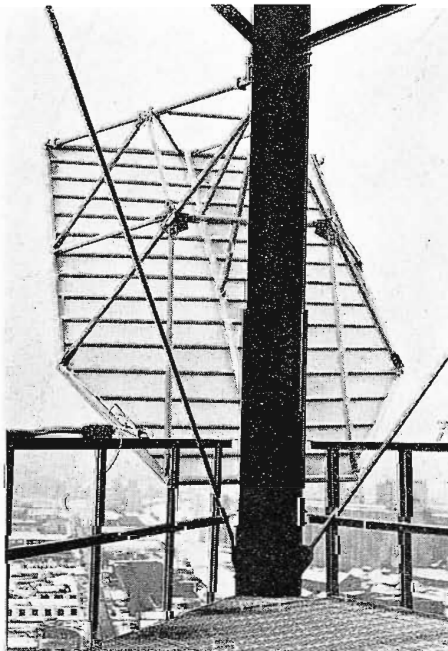

FIG. 47. Nine hop KCMT-WDAY system feeds NBC programs from KSTP as far as Fargo, N. D.

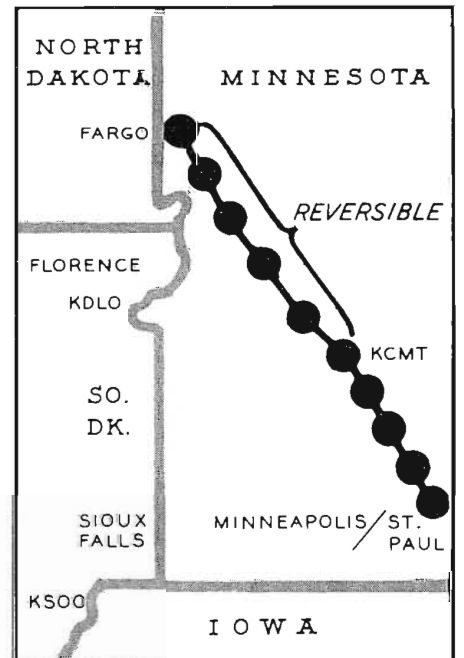



FIG. 48. KSTP photo-news staff of 33 photographers, writers, editors, technicians.

FIG. 49. John MacDougall, newscaster, at head of makeup table. From top to bottom: editor Bob Johnson, director Dick Larson, floor director Ed Hammeril.

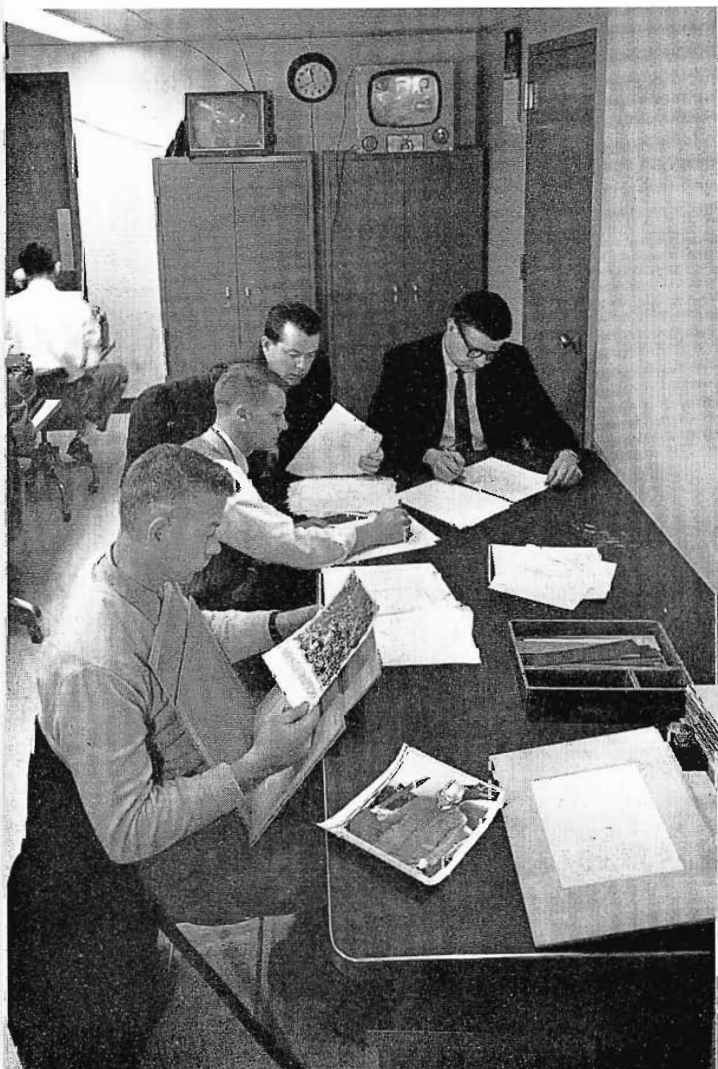

FIG. 50. Editing facilities in photo department. Film editors and news writers work side-by-side to cut news films.

Photo-News Department

A staff of 18 nationally accredited motion picture news photographers, supported by writers, film editors, and photographic technicians make a total staff of 41 people, for handling KSTP's very extensive TV News Department. It is completely equipped for producing 16mm color/monochrome, silent and sound films. Also, color/monochrome 2 by 2 slides and 3¼ by 4-inch rear projection slides.

The Photo Dept. has a high-speed continuous color processor, and monochrome reversal 16mm automatic processor. Also, darkroom laboratories for still reproductions. Facilities are available for either optical single or double system sound track recording—or pre-stripping magnetic sound recording.

The award-winning news staff of reporters and writers is supported by 90 assistant photographers and correspondents. Five photo news cars, an emergency mobile lighting unit, and two airplanes with staff pilots, are all tied together and in communication with HQ via 2-way radio.

To back up these facilities there are complete motion-picture and still picture morgues, and all the wire services.

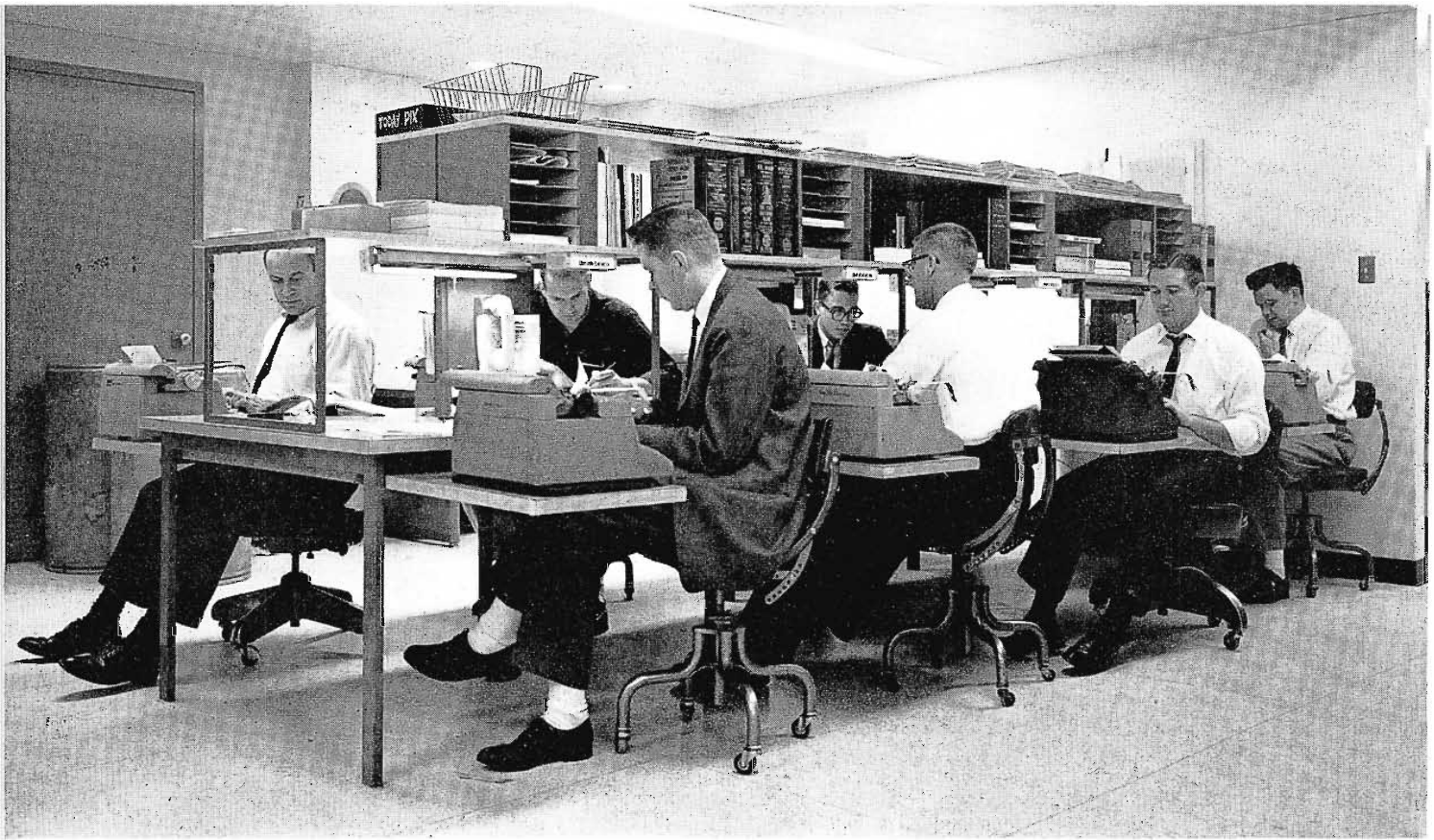

FIG. 51. Fifteen writer-reporter-producers are responsible for programming some fourteen hours of regular news shows each week—plus many specials.

FIG. 52. Jack Wadlund checks latest wire copy before writing a story for the news show.



FIG. 53. Assistant TV news director, Lowell Ludford, clears the wire. In addition to AP and UPI radio wires, KSTP subscribes to AP's "A" and "B" wire services, plus the weather wire and photo-facsimile.



FIG. 54. Bud Meier, news director and Bill McGovern, director of KSTP news operations, plan "in depth" coverage for which KSTP is famous.





FIG. 55. KSTP employs a fleet of eight vehicles in its photo-news operation.



FIG. 56. Radio dispatcher, Jerry Weirbrauch, monitors emergency frequencies and contacts KSTP vehicles. Double pane window keep out noise.



Gathering News Story

Following the example of its founder, this department makes a fetish of offering a comprehensive and unbiased view of the news in the surrounding communities. Like its owner-operator the two news directors have a quarter century's experience in the broadcast news business. The Hubbards' philosophy is very evident in that news is treated not as entertainment but as business.

Efficiency is the keynote of the new organization. To get efficiency this complex operation requires many people and much equipment. Having procured both, KSTP is able to offer one of the finest news services in the nation.

Radio News Control

The Photo-News Department employs radio equipped vehicles. Each car is equipped with at least one 2-way radio for communication with the dispatcher. The cars also contain emergency frequency monitors and give on-the-spot air broadcasts.

A lighting truck is used for emergency power or lighting at any situation in which it can be used. Quite often, this truck is requested by local authorities to assist them on emergencies, manhunts, etc. Mounted on the roof are two mercury vapor flood lights of 1500 watts each and one 2000 watt spotlight. The generator in the truck is a 35 kw unit, delivering 120-208 volts, 3-phase, 4-wire, 100-amps.

FIG. 57. Photographer Roger Anderson fitting zoom lens to cine camera with transistorized amplifier for recording sound on film.

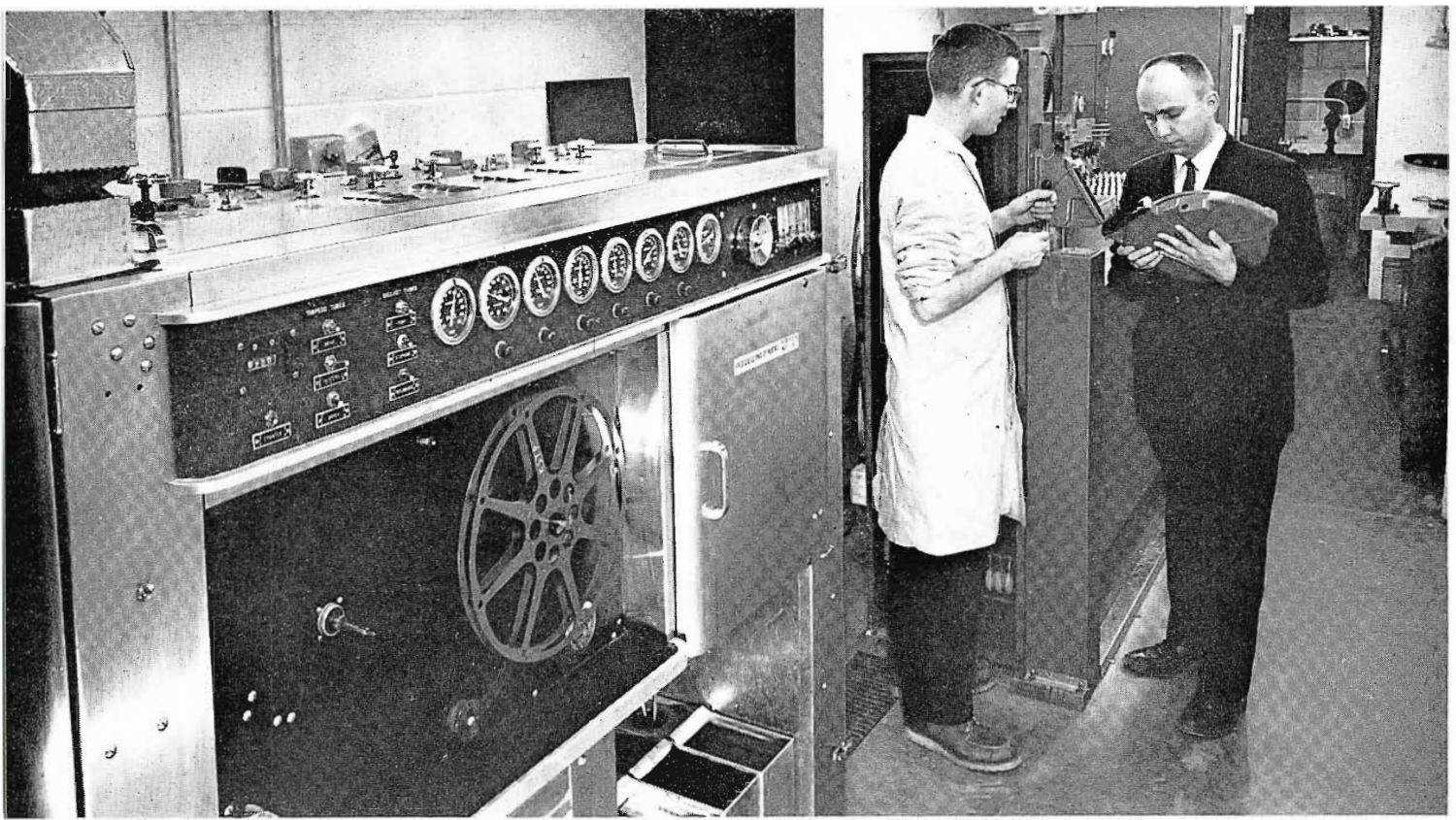

FIG. 58. Inspecting monochrome and color film processing facilities: Skip Nelson (right), photo news director, and Leon Lacabonne, color control specialist.

Color and Monochrome Processing

A Hills Filmatic reversal processing machine is currently being operated at 75 fpm for monochrome. Recently installed is a Hills Colormatic reversal processor. This operates at 25 fpm using a high-temperature, high-speed process developed by Ansco.

The air in the room is specially air conditioned, and includes electronic air cleaning. Both processors operate from a unique system of water in tube and drainage built into the floor. Chemical processing solutions are fed to the machines from overhead 25-gal. storage tanks by special plastic tubing. The tanks are fitted with floating lids and dust covers.

Control of processing quality is constantly being exercised. Equipment and procedures for chemical analyses are at hand and carefully followed. Densitometer readings are made regularly on monochrome and color film. A laboratory technician on the staff assures constant high quality of processed film.

KSTP Radio

Stanley Hubbard established one of the first commercial radio stations in the American system of broadcasting and has guided it to the place of national prominence that it holds today. Following in the footsteps of his august father and pioneer, Stanley "Jr." is today manager of the radio operation, and of radio and TV news.

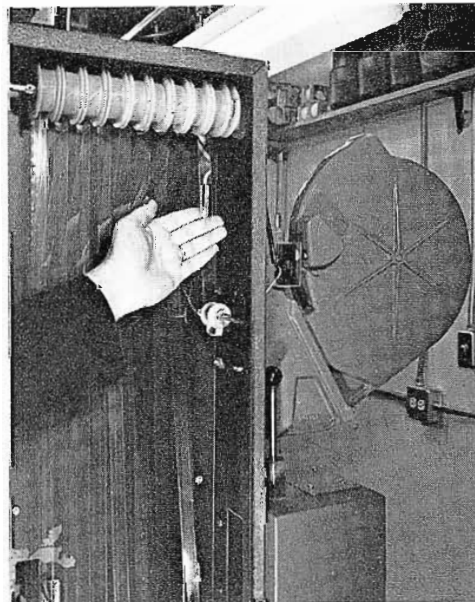

FIG. 59. Special devices added by KSTP to color processor so that film cannot jump off roller; also note micro-switch to indicate low film supply.



FIG. 60. Note floor drain system beneath film processor.

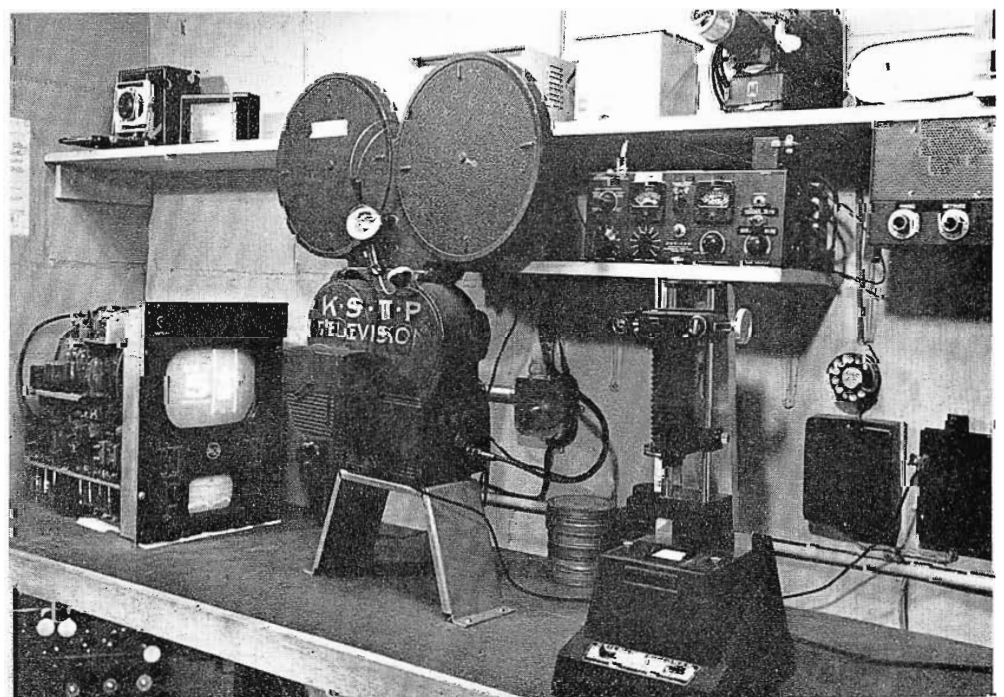
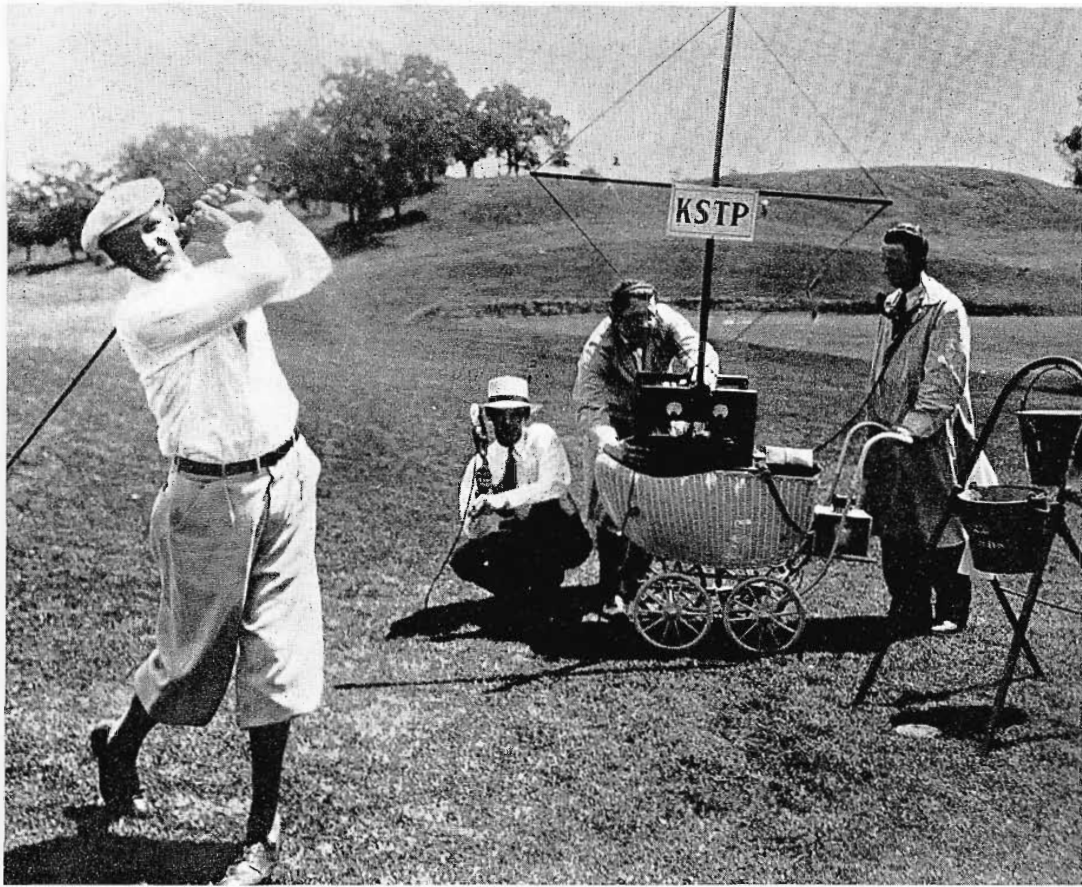

FIG. 61. Auricon Pro fitted with Mitchell 1200-ft. magazine is mounted in front of TM-6 master monitor for kinescoping.



Under his able guidance the station is a living symbol of the free enterprise system of broadcasting.

Reason for the continued growth is emphasis upon modern techniques and public service. It is for this reason that the old AM control room is now being modernized. This is also why RCA Cartridge Tape machines are employed and why the AM 50-kw RCA Amphiphase transmitter has been installed. These are latest and most efficient operating equipments for AM radio stations.

All commercials are recorded on tape cartridges to speed selection and to reduce errors. From 250 to 500 spots in one day are poured forth from the cartridge tape machines. In addition NBC programs recorded on these machines are frequently played at later dates. They are also used for pre-recording local shows.

The Amphiphase transmitter was chosen because of its reliability and quality of sound. It gives FM-like performance to an AM station. Its stability insures that the station will stay on air with highest reliability.

Thus in all ways KSTP is endeavoring to fulfill its pledge to serve the public interest. Whether in radio or television the best and most modern of equipment and techniques are employed. This mark of the pioneering spirit is further evident in the switch to color, by KSTP-TV, making it the first station in its northwest area to offer the finest in television fare for its advertisers and to its audiences.

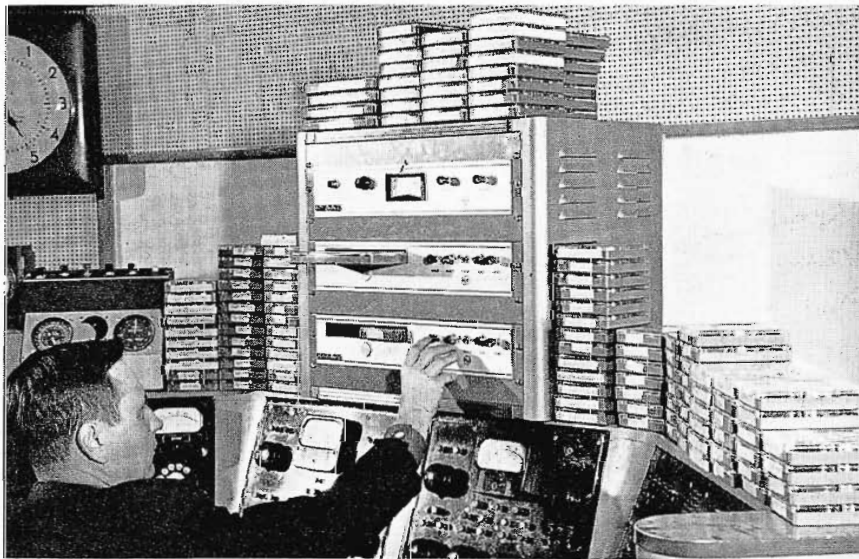

FIG. 62. (top) One of earliest radio remotes by KSTP, made from one of the first mobile units in the nation.

FIG. 63. (center) Cartridge tape units are most recent addition, finding extremely heavy use. Howard Hefley, technician, loading cartridge.

FIG. 64. (bottom) AM radio control room. This is in process of being modernized.



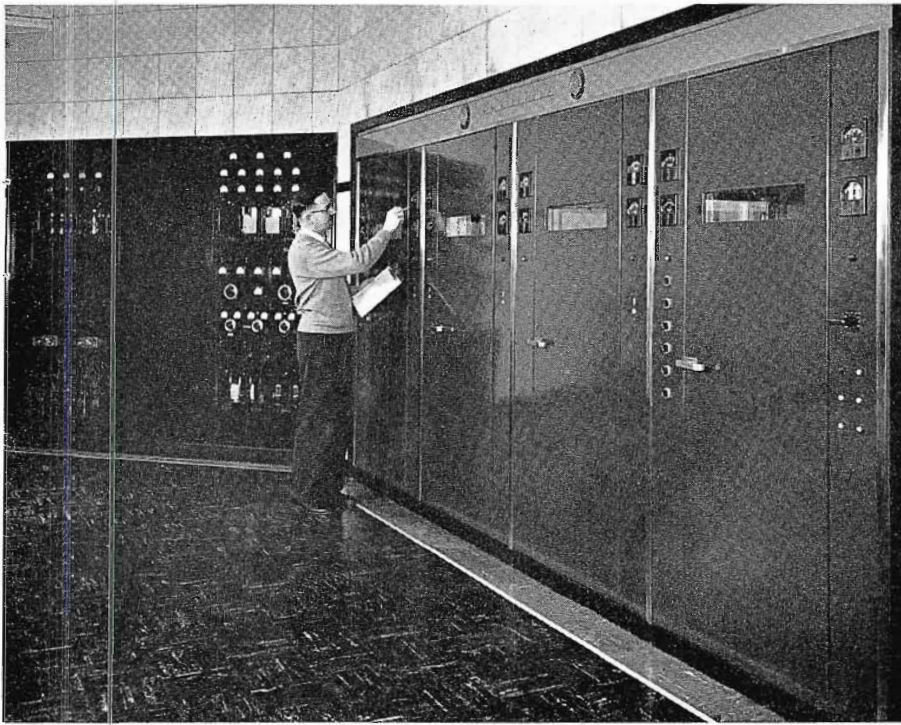

FIG. 65. AM Transmitter supervisor, Howard Carlson, at RCA 50-kw Ampliphase transmitter. At left is 1-kw auxiliary transmitter.

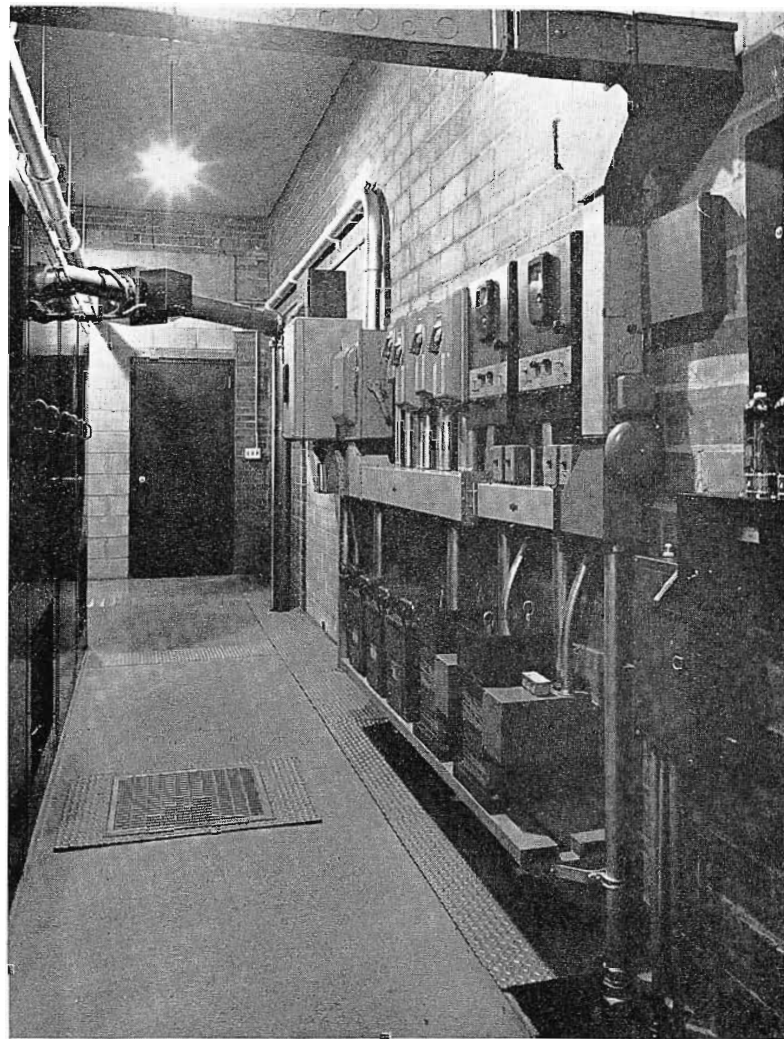
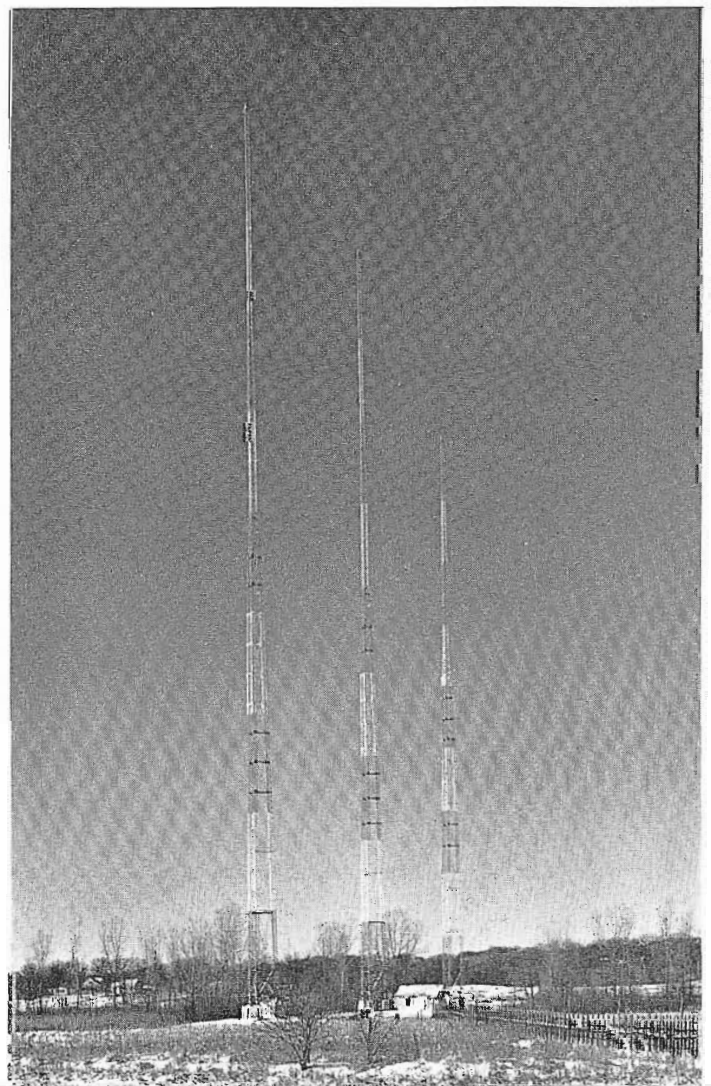

FIG. 66. Note neat and compact arrangement of power and control equipment for 50-kw ampliphase transmitter.

FIG. 67. KSTP-AM transmitter building. In background is emergency antenna, 165 feet high. (Bat wings at top are for FM.)

FIG. 68. KSTP beams power westward at night, is non-directional in daytime. First tower is 340 feet high and is top loaded. Second tower is also 340 feet high while third is 296 feet high.



CREDITS

Photography: Skip Nelson, TV Photo News Director and Ken Espe, Photographer, KSTP.

Equipment Planning: W. B. Varnum, Manager, Studio Equipment Merchandising, RCA Broadcast and Television Products Dept.

Expansion, Remodeling, Air-Conditioning: R. W. Gish, Vice-President, Hammel and Green, Inc.

Technical Data: L. Larson, Director Engineering Research and Development and F. Street, Director Engineering Operations, KSTP.

AIR BEARING HEADWHEEL PANELS FOR RCA TV TAPE RECORDERS

by FRANK M. JOHNSON
Broadcast Equipment Engineering

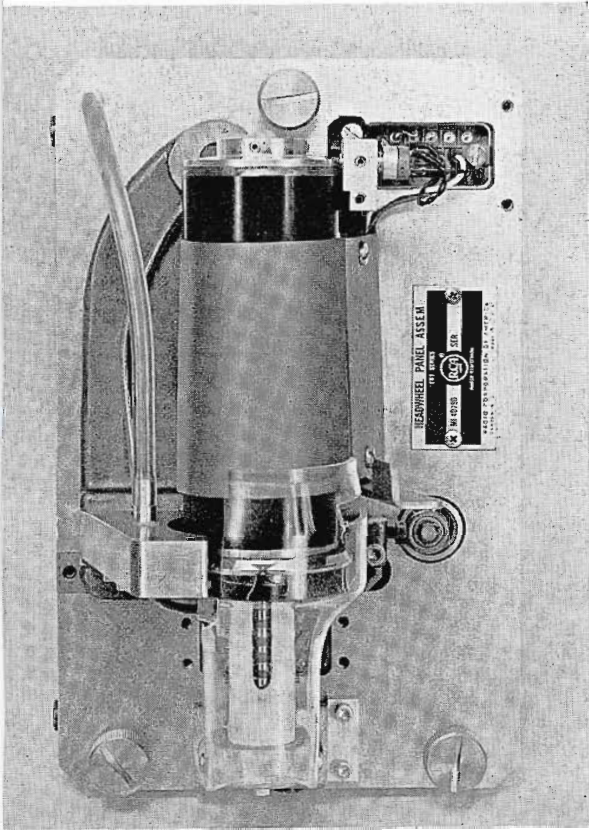

FIG. 1. Air bearing headwheel panel—available for use with all RCA tv tape recorders.

Introduction of air bearing headwheel panels for use with RCA TV Tape recorders is a major step in the steady improvement of this equipment. Advantages made possible by floating the motor shaft and headwheel on a film of air are numerous. Use of air bearings leads to steadier pictures because of the elimination of a source of vibration. Longer life results because there is no metal-to-metal contact as the motor shaft revolves. Another result is superior Pixlock operation because of more uniform rotational drag characteristics of the air film.

The air bearing panels are available for use with all RCA TV Tape recorders. They may be used interchangeably with ball bearing panels by installing an air supply system kit. TRT-1B and TR-11 recorders can be modified to use these panels in about five man-hours. The new transistorized TR-22 recorder includes the air supply system as regular equipment.

Freedom from Vibration

Probably the most important feature of air bearings for video use is their complete lack of vibration as compared to the characteristic spectrum of vibration of ball bearings. In the vibration plot of a ball bearing, Fig. 2, noise components may extend from one hundred cycles per second to ten thousand cycles per second. The amplitude of the noise varies through the frequency range. Because of the metal-to-metal contact of the balls on their inner and outer races, there is always some vibration at many frequencies. Ball bearings when judged acceptable with respect to vibration may produce picture jitter when the panel plays back its own recorded signal. This is a more severe test for picture jitter than playing back a standard or perfect tape, because the jittering signal is compounded as the vibration fault is first written on the tape and then read with the same fault. The error is correspondingly doubled. This condition is compounded

further if the headwheel is used to make additional copies of its recording.

The vibration plot of an air bearing (also shown on Fig. 2) has no detectable vibration except the shaft speed frequency, and this may be reduced in amplitude by counterbalancing. The 360 cps frequency which is the electrical drive frequency of the 3-phase motor, the slip frequency of 120 cps (which is the difference between the drive frequency and the shaft speed), and the harmonics of these may show on the plot as vibrations. These are drive vibrations and may be changed by changing the drive frequency should they cause picture unsteadiness.

Air Flow

The air bearing video headwheel panel is supplied with one-half cubic foot of air per minute at a pressure of thirty-five pounds per square inch. This air enters each bearing through six central throttling orifices, as may be seen in Fig. 3, so that

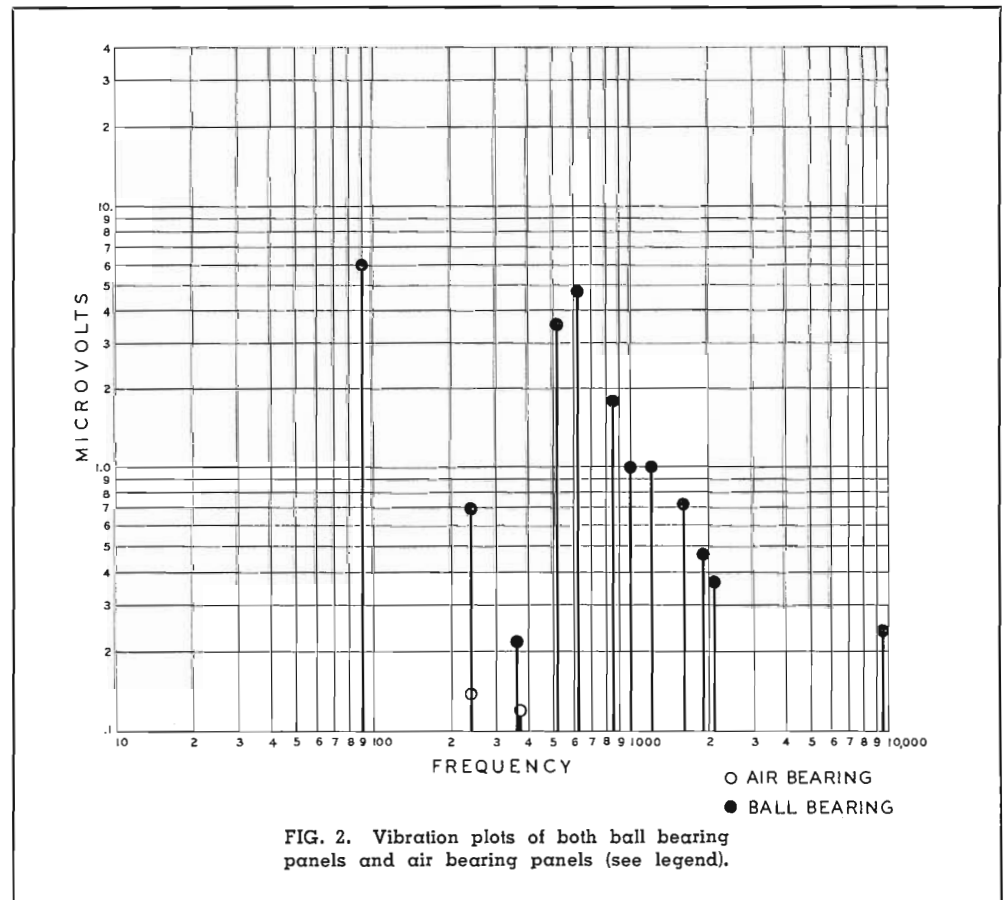

FIG. 2. Vibration plots of both ball bearing panels and air bearing panels (see legend).

the shaft is held equidistant from each orifice by air pressure. If the shaft is pushed toward an orifice (thereby reducing both the clearance and flow of air from the bearing at this point) the pressure against the shaft increases. On the opposite side of the shaft, the air pressure is reduced due to increased clearance which allows the air to escape as the throttling orifice restrains the supply of air to this part of the bearing. This action is the centering influence which holds the shaft in the center of the bearing before it starts to rotate and also at full speed. A simple, sturdy design results which gives smooth operation and high reliability.

Long Life Design

Another important feature of the air bearing is its unlimited life, provided it is supplied with clean, reasonably dry air. This is due to the complete flotation of the shaft, and the elimination of metal-to-metal contact. Ball bearings are classified as frictionless because the relative motion of the contacting metal is a rolling contact, and the area is a small oval less than the head of a pin. Yet grease is necessary to lubricate the rolling balls and to reduce their wear. The life of the ball bearing is limited by loading, speed, and the amount of grease which can be kept in contact with the balls.

The only part that wears in the air bearing is the lubricant, air. This means that the air bearing will have a life limited only by obstruction or supply failure. Should these occur the likelihood of repair is excellent due to the use of very hard materials which resist the abrasion of most dirt and are non galling.

It is obvious that ball bearings are performing creditably today, but they do have risk characteristics which are magnified as the life of the magnetic heads is increased. The continuing search for materials and designs to increase the life of the magnetic heads indicates that head wear life may be greatly extended and it is important that the bearing system does not detract from the magnetic head performance nor reduce its life span. Air bearings have been known to function continuously for years and obviously meet this requirement.

Picture Improvements

Another characteristic of air bearings is shown to advantage when using the RCA Pix-lock system. This is an advanced servo system which synchronizes the output picture signal from the tape recorder with the local sync generator by comparing tape-produced horizontal sync pulses with the local signals. Here the uniform drag of the

air film reduces rotational vibration of the headwheel and results in consistent lock-in and superior picture stability.

The quadrature angles of the magnetic headwheels may be expected to show less deviation in the air bearing panel. This is because the bearing surfaces are never replaced nor do bearing elements rotate, as do balls, to cause changes in the center of rotation. The air bearing shaft is one large part, which is precisely round, and establishes the axis of rotation about which the heads rotate.

Air bearing assemblies are very rugged. They are not subject to damage by shocks or vibration such as might "brinell" the

ball bearings during shipment. Also, thermal effects of the motor shaft have not been evidenced. Air bearing motors run cooler than ball bearing motors, require less drive power than ball bearing motors.

Technological Advance

The air bearing video headwheel panel assembly offers considerable improvement in life, performance and overall economy of tv tape headwheels. It has been established as a major step from which greater improvements in performance and picture quality are possible. The basic simplicity of its design promises greater reliability and superior service to tv tape operations.

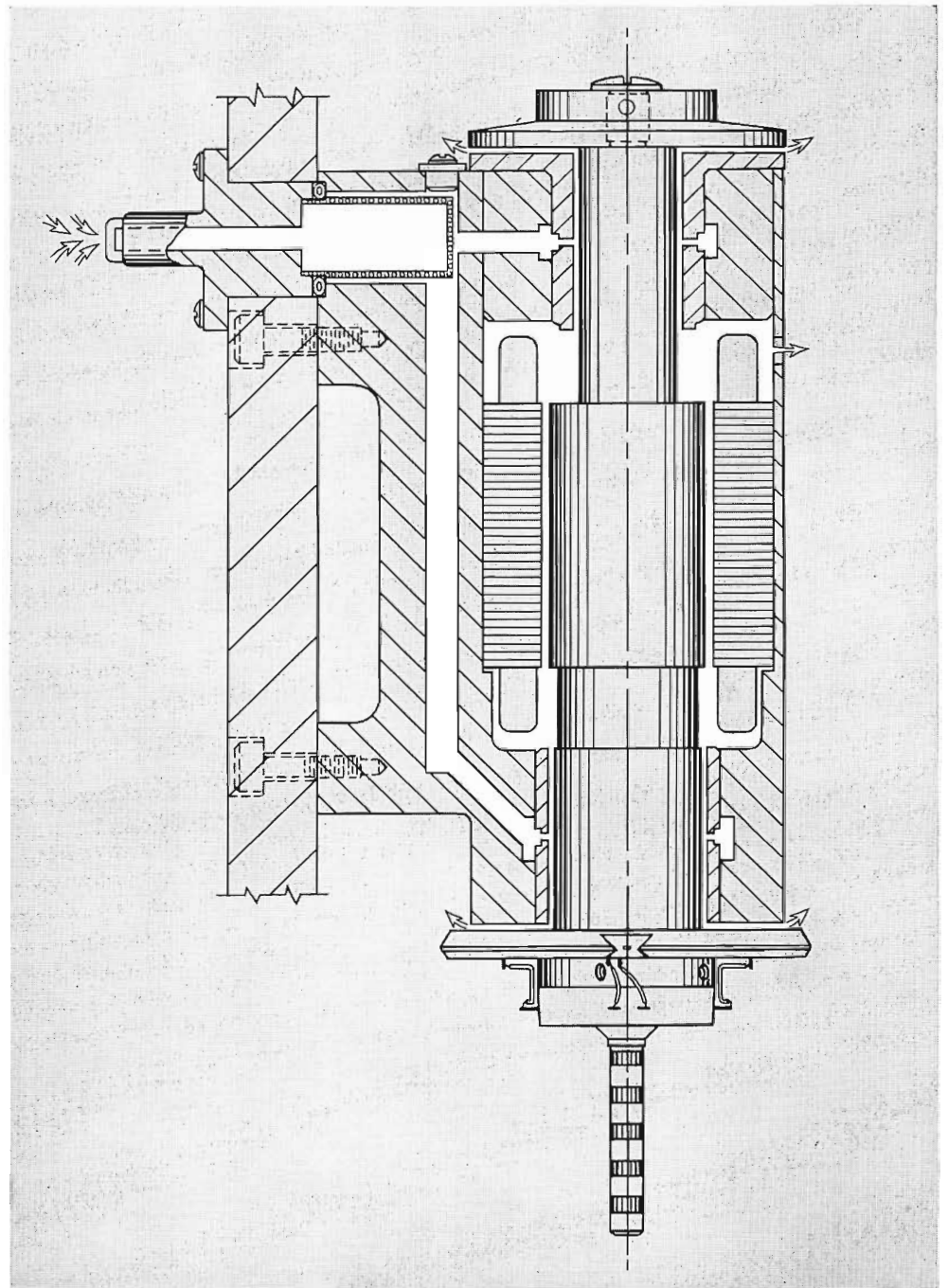

FIG. 3. Cross-sectional diagram of air bearing panel. Air flow is shown by white areas.

UNIVERSAL PICKUP CARTRIDGE FOR BROADCAST TURNTABLES

Features Replaceable Stylus For Both Stereo and Monaural Operation

by J. R. SANK

Broadcast and Television Engineering

The new Universal Pickup Cartridge has been designed especially for broadcast applications. Prompted by the need for excellent quality broadcast reproduction of stereo recordings, the new cartridge is unique in that it performs in both stereophonic and monophonic applications. The mode of operation is determined by external electrical connections to the cartridge. A replaceable stylus is a feature of the cartridge design. The stylus plugs directly into the cartridge and is easily replaced without the need for costly and time consuming factory repairs. This plug-in feature also allows a user to buy only one type of cartridge and several sizes of economical stylus in order to take care of all record playing requirements.

Utilizing the moving-magnet principle,¹ the new universal cartridge is molded in a black plastic case with three terminal pins. The center pin is common and the outside pins are the left and right stereo outputs. In stereo use the head is connected in the usual manner with the left output going to the left equalizer and the right output, to the right equalizer. In monophonic use, the

¹ Horowitz, H. "Moving Magnet Stereo" *Audio* May, 1959, P. 19.

left and right outputs are paralleled. The cartridge plugs into the standard RCA 12-inch and 16-inch tone arms, or may be mounted on arms with standard 1/2-inch mounting centers. It features low distortion, excellent frequency response and very good channel separation. The diamond stylus and low tracking force insure long life for both the stylus and recordings.

arm contains a bar magnet which rotates in an elastomer pivot bearing. A wire spring, extending from the magnet, is soldered to the end of the brass stylus assembly holder. The cartridge body contains the coils, shield, and magnetic circuit. Plug-in stylus assemblies, readily identified by color are available in three types as shown in the accompanying table.

STYLUS SPECIFICATIONS				
MI Number	Stylus (Tip Radius)	Function	Force (grams)	Color
11866-7	0.7 mil	Stereo records	4	Black
11866-10	1.0 mil	45 RPM and LP records	4	Red
11866-25	2.5 mil	Transcription and 78 RPM records	8	Green

Replaceable Stylus

The stylus assembly is mounted in a brass holder which is fastened to a convenient plastic guard, making replacement exceptionally easy. To protect against damage should the pickup be dropped accidentally, the tubular stylus arm retracts into the guard. The inner end of the stylus

The 0.7 mil stylus, MI-11866-7, is for stereo applications—it must be used to play stereo recordings, but may also be used to play 1 mil standard records without appreciable change in performance. With this stylus, stereo recordings can be reproduced for monophonic broadcasting by paralleling the left and right outputs of the pickup head.

The 1.0 mil stylus, MI-11866-10, is used for reproduction of standard recordings.

The 2.5 mil stylus, MI-11866-25, is used to reproduce 78 rpm records and certain old-type transcriptions cut with a 2.5 mil groove.

The 0.7 mil stylus force is 4 grams. This provides record life equivalent to that obtained with the 1.0 mil MI-11874 pickup operating at 8 grams. (Stress on the groove is inversely proportional to the square of the stylus radius.) The 1.0 and 2.5 mil stylus assemblies operate at 4 and 8 grams respectively.

Technical Features

The impedance of each channel in the cartridge is essentially a 4 mh inductance. Recommended load impedance is 47 K

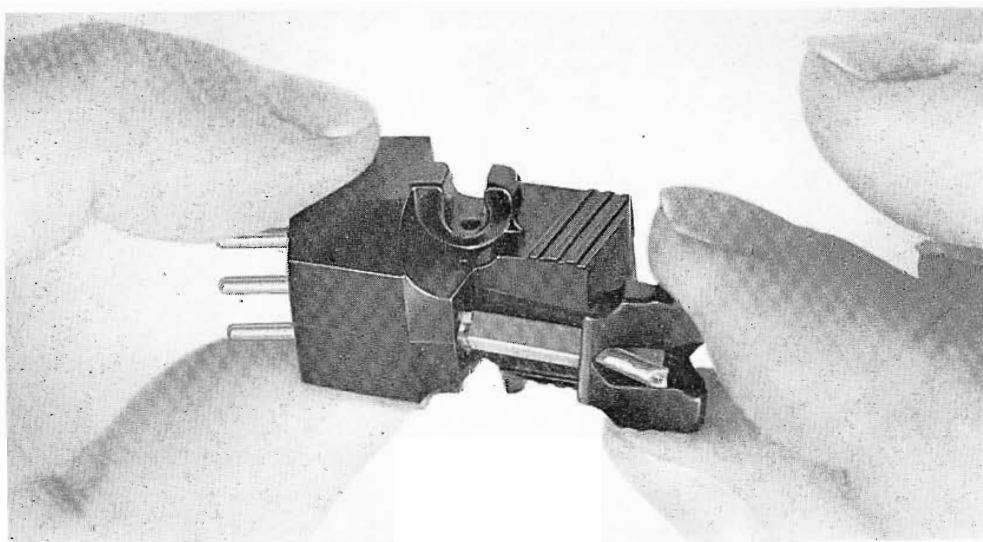

FIG. 1. Replaceable stylus construction eliminates the need for costly repairs in this new Universal Pickup Cartridge.

shunted by no more than 400 pf. A pair of BA-26A equalized preamplifiers will properly load the cartridge for stereo. A single BA-26A is used in monophonic reproduction.

The new stereo pickup has a very significant characteristic which makes it particularly suitable for broadcast use, i.e., low distortion. This may seem to be an obvious and essential requirement for any pickup. However, the methods of measurement and criteria for evaluating distortion have not been universally agreed upon. Thus, it is very difficult to find distortion data published on commercial pickups. Data contained in this article was obtained by the two-frequency method.^{2,3}

The popular concept of modern high fidelity reproduction has caused considerable emphasis to be placed on extremely smooth high frequency response in the pickup. This frequently is obtained by sacrificing low distortion performance so essential to the broadcaster. Although moving system mass referred to the stylus tip is greatly reduced, a high frequency resonance with the vinylite record will still occur within the audible range. The smaller stylus radius (0.7 mil) required for stereophonic records has reduced the reflected stiffness of the record, resulting in a lower

resonant frequency. Therefore, the highest resonance obtained in practical designs is the 15,000 cycle region.

Many pickup designers have sought to dampen this peak by the use of mechanical resistance materials. Unfortunately, virtually all such materials do not supply true viscous damping. They are amplitude sensitive, and contribute significant amounts of non-linear distortion,⁴ depending on how much damping is required.

The new RCA pickup employs very little damping. The elastomer part acts primarily as a bearing, with the wire spring supplying most of the moving system stiffness. Lateral distortion is shown in Fig. 2. The curve shows inter-modulation distortion, which is a measure of the non-linear distortion occurring at the lower test frequency. The RCA 12-5-39 test record contains 400 and 4000 cps mixed 4 to 1. Harmonic distortion methods at 400 cps could alternately have been applied, but have been found to be much less practical than the intermodulation method.³ Ten per cent intermodulation distortion is not noticeable without a chance for direct comparison, analogous to a figure of 2 or 3 per cent harmonic distortion.

The maximum peak level at 1000 cps on an NAB lateral disc is 21 cm/sec. Referred to 400 cps on the NAB recording characteristic, this becomes 13.5 cm/sec. Therefore, RCA pickups have approxi-

mately a 6 db margin of safety, which allows for the frequently encountered "over-recorded" disc.

Vertical distortion of the new pickup has not been measured, as there is no standard test record. A standard vertical tracking angle has not yet been adopted by RIAA or NAB. The angles of commercial cutting heads vary from about 19 to 30 degrees, so a compromise angle of 26 degrees was chosen for this pickup.

Frequency response and channel separation are shown in Fig. 3. These have been measured with a Westrex 1-A Stereo Test Record, with a load of 47 K plus 350 pf per channel. With the high frequency peak evident, response is maintained within ± 3 db 30 to 15,000 cps due to the small moving mass.

Greatly reduced distortion has been achieved with only a small departure from flat response. Hence, superior playback quality is obtained for both stereophonic and monophonic recordings.

Complete Package

Use of the new Universal Cartridge complements a complete RCA package designed to give finest sound from recordings and transcriptions. The package includes the cartridge, a selection of replaceable styli, 12 or 16-inch tone arms, and BA-26A transistor preamplifier equalizer. Each of these equipments are matched—both electrically and mechanically—for finest performance in both stereophonic and monophonic use.

² Roys, H. E. "Analysis by the Two Frequency Intermodulation Method of Tracing Distortion Encountered in Phonograph Reproduction." *RCA Review*, June, 1949 — P. 254.

³ Roys, H. E. "Distortion in Phonograph Reproduction" *Journal of the Audio Engineering Society*, January, 1953.

⁴ Horowitz, H. "Moving Magnet Stereo" *Audio* May, 1959, P. 21.

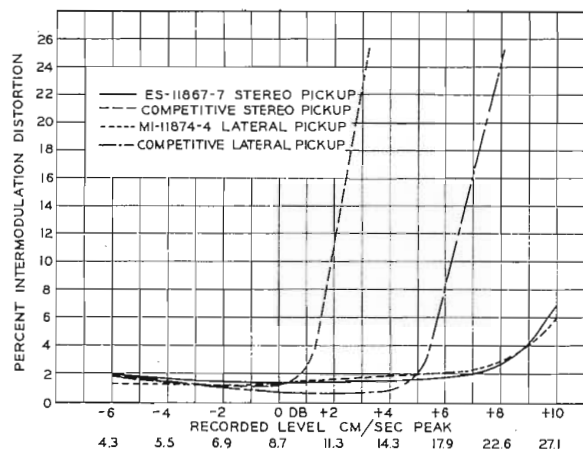

FIG. 2. Lateral intermodulation distortion vs recorded level, RCA 12-5-39 Record.

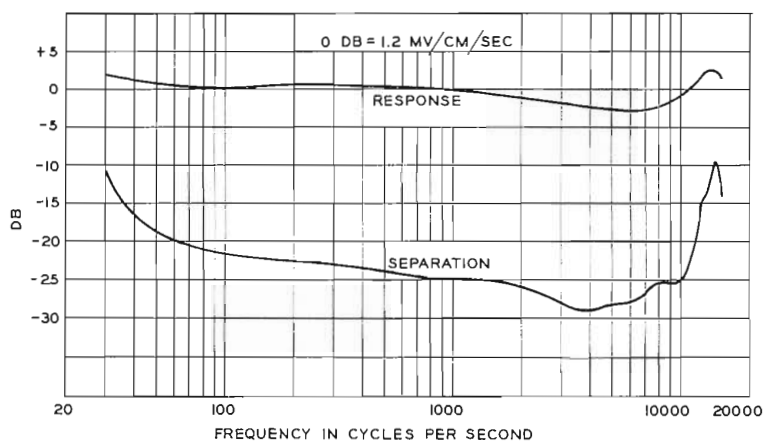

FIG. 3. Frequency response and channel separation, Westrex 1-A Record.

STEREOPHONIC PHONOGRAPH RECORDS, PHASE RELATIONS, AND STEREO BROADCASTING

by H. E. ROYS

*Chief Engineer,
RCA Victor Record Division*

Stereophonic recordings involve two separate channels of information. In order to achieve the acoustical perspective, depth, spaciousness and other benefits that are possible, great care must be observed to maintain the proper phase relationship between the two channels of information, both in recording and reproduction. The same care must be observed in FM stereo broadcasting. This is particularly true because the transmission may be reproduced either stereophonically or monophonically, and it is essential that the quality of reproduction be the best possible in either case.

The phonograph industry readily recognized the importance of phase relationships of the two channels and quickly established standards in order to assure a uniformity of product. Since it is quite likely that many stereo records will be used as program material in FM broadcasting, it was thought that an article describing the record standard, giving some of the reasoning involved and including some helpful hints, would be of interest to the broadcaster.

The Stereo Record

The 45°-45° stereophonic system chosen by the Record Industry Association of America (RIAA) as a standard was selected after careful consideration of the available systems. It was selected, for one reason, because of the compatibility that can be achieved with respect to monophonic reproduction. To achieve this, the RIAA standard states:

In 45°-45° stereophonic disc phonograph records, equal and in-phase signals in the two channels shall result in lateral modulation of the groove.¹

As illustrated in Fig. 1 for the 45°-45° system, the two channels of information are recorded in a single groove with the modulation axis of the two systems at right angles with respect to each other, and 45° with respect to the surface of the record. The diagrams at the left and right, A and B, show the type of groove obtained when an identical signal is applied to the left and right coils separately and then together. It is important to note that in Fig. 1-C vertical modulation results if the signals are equal in amplitude but out of phase. Likewise, Fig. 1-D shows that lateral modulation results if the two signals are equal and in-phase.

In terms of record reproduction, if in the case of 1-D the recording is reproduced with a suitable lateral pickup, information from both channels will be present. The sound quality will be like that of a monophonic record that had been cut with a lateral recorder where the signals had been obtained by combining the output of the two channels electrically. If the phase is reversed, as is the case shown in Fig. 1-C, the modulation of the groove will be vertical and the results will be poor due to cancellation of the lateral components.

¹ RIAA Engineering Bulletin E-3.

The problem of correct phasing is similar to that which must be observed in stereophonic broadcasting where monophonic reproduction is the sum of the left and right (L and R) channels. The phase relationship is of importance since an incorrect phasing will result in considerable cancellations, particularly at low frequencies. Only if the proper phasing has been observed, will the sound quality be satisfactory.

Evaluating Stereophonic Records

A simple method of judging the monophonic quality of a stereophonic record is to reproduce it monophonically. This may be achieved by using a suitable lateral pickup and reproducing the record over a single channel amplifier and speaker system. By suitable is meant a pickup designed for monophonic record reproduction, one that has sufficient vertical compliance to properly track the vertical undulations of a stereophonic record without undue distortion or damage to the groove. A stereophonic pickup with the output leads tied together for monophonic reproduction provides a ready means of providing such a pickup.

Another method and one that might offer greater appeal to the broadcaster is to combine the outputs of the two pickup channels at the outputs of some of the amplifiers along the chain. When doing this, there may be some question about the channel gains and the phase relationship. These may be easily checked by playing a lateral frequency record. The VU meter readings for each channel should be equal. If the phase relationships are incorrect, the single VU meter that reads the combined outputs will show a drop in output as the channels are connected together.

The cancellation of signals due to improper phase relationship when reproducing music records results in a loss in the low frequencies and undesirable high frequency characteristics. When the phase and gain relationships are correct, a properly recorded stereo record will show nearly undetectable tonal balance differences be-

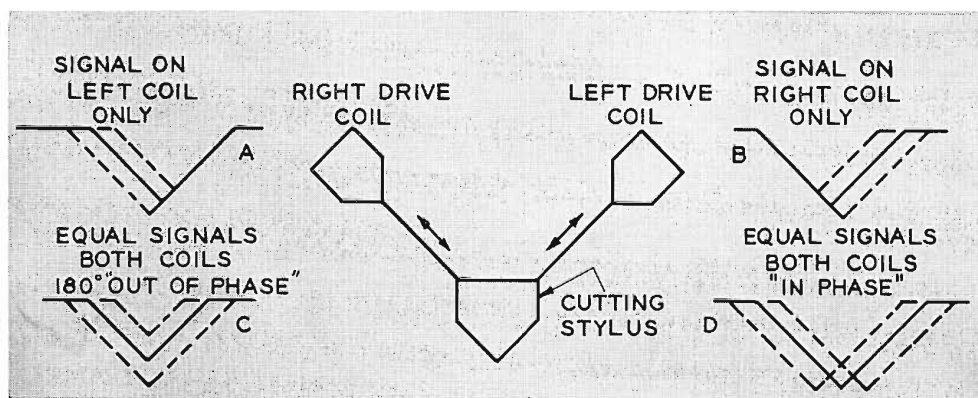

FIG. 1. 45°-45° Stereo Disc Recorder.

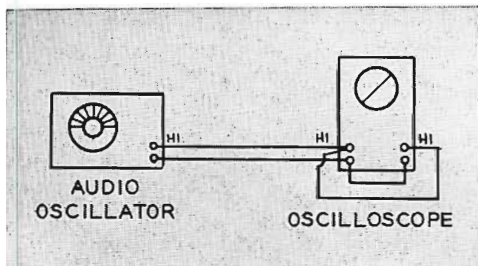

FIG. 2. Phase Indicator.

tween monophonic and stereophonic reproduction. The stereo reproduction will, of course, exhibit acoustical perspective, depth and spaciousness due to the additional information since it is derived from two channels instead of one.

Phase Checking Methods

Realizing the importance of observing and maintaining the proper phase between the stereo channels, a logical question that arises is: How can one check the phase relationship. Ideally, the two channels should be exact duplicates throughout their operating range. Frequency and phase response should match closely. In general, the phase relationship is the most difficult one to measure. However, with the aid of an audio oscillator and an oscilloscope, simple observations can be made that will determine whether or not the connections are in-phase.

If an audio oscillator is connected to an oscilloscope, as illustrated in Fig. 2, with the high side of the oscillator connected to both high side terminals of the oscilloscope, a straight line inclined at a 45° angle to the right should be observed. Since this is a common signal equal in amplitude that is being applied to the oscilloscope, it is obviously the in-phase condition. If two signals of the same frequency and amplitude were applied 180° out of phase, a 45° line would be observed which would slope towards the left. A 90° phase shift would result in a circle.

The oscillator and oscilloscope provide a simple set of tools for determining the "in" or "out" of phase conditions. They may be used for microphones and loudspeakers as well as amplifiers. The arrangements for such measurements are shown in Fig. 3, 4 and 5. When acoustic transmission is involved, a low frequency such as 200 cycles should be used to minimize phase differences due to the transmission of the signal through air. When checking loudspeakers as illustrated in Fig. 5, a quick check of the system can be made by first placing both microphones in front of one loudspeaker and noting the trace on the oscilloscope. The same trace should result when the microphone is shifted back to its original position. For checking the phase relationship of high frequency speakers,

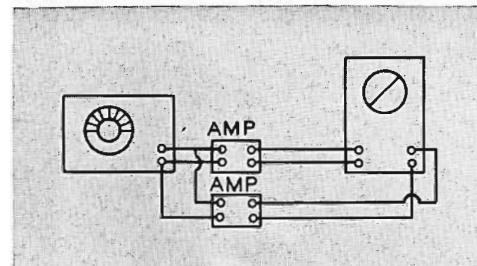

FIG. 3. Checking Amplifiers.

EIA² recommends that direct current be used and the direction of motion of the diaphragm be observed, or a sensitive dc meter be connected across the terminals and the polarity of the voltage noted when the diaphragm is moved manually.

Conclusions

It is quite likely that in the beginning FM stereo broadcasts will be heard largely on monophonic receivers. In order to retain public acceptance, it is necessary that the quality of the monophonic reproduction be equivalent to that obtained from monophonic transmission. Phase relationships of the signals of the two channels are important. Stereophonic records made in accordance with RIAA standards will provide program material suitable for both monophonic and stereophonic reproduction.

² EIA Standard RS-233 "Phasing of Receiver Loudspeakers."

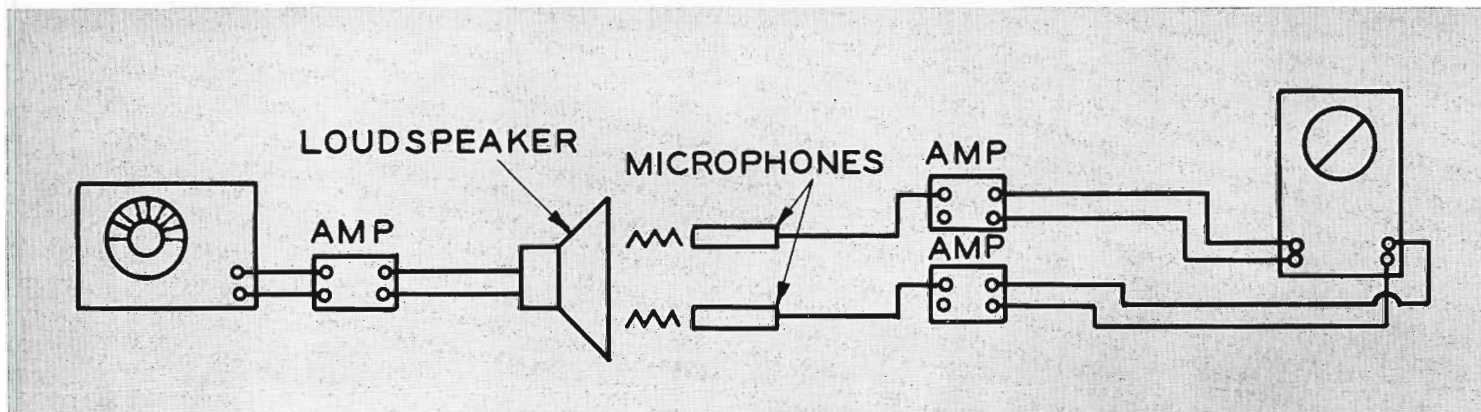

FIG. 4. Checking Microphones.

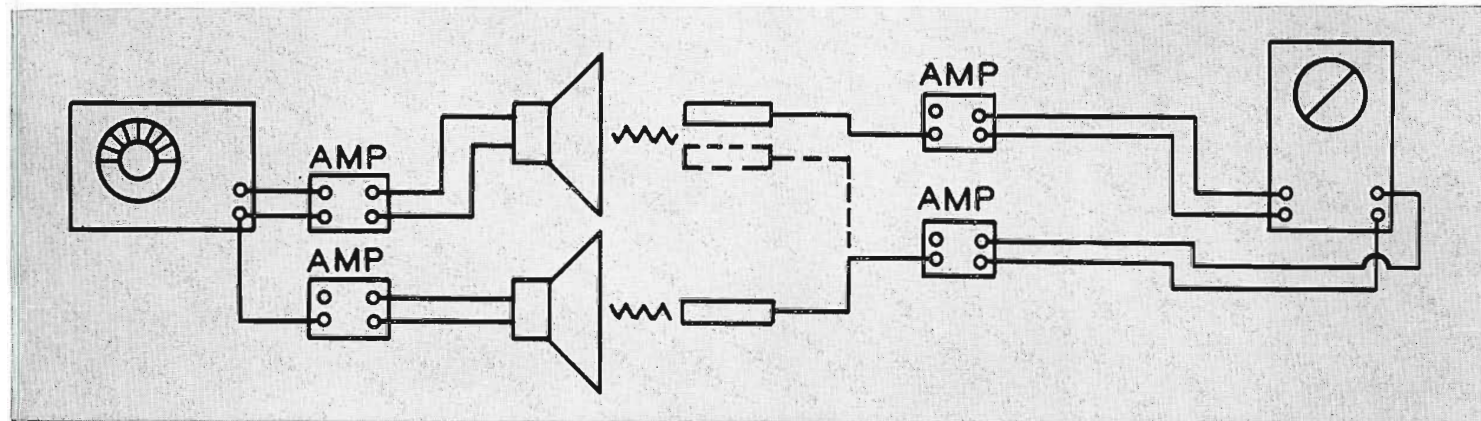

FIG. 5. Checking Loudspeakers.

USERS REPORT ON RCA TS-40 SWITCHING EQUIPMENT

System Flexibility, Dependable Service,
Excellent Performance Acclaimed In a Wide
Variety of TV Applications

Today, more than 100 TS-40 Transistor Video Switching Systems are in use in television studios throughout the industry. The systems themselves take several different forms—some are standard-design switchers available from RCA in four standard packages, others are either partially or completely custom designed.

Whether standard or custom, each installation takes on its own individual character from the way it is used by the station.

This article is a roundup of some reports on how tv stations have installed and are using TS-40 Switching Systems. The variety of arrangements shown demonstrates the unique system flexibility

of this modern new equipment. Dependable service and excellent quality performance emerge as common operating characteristics.

The following pages tell how stations are using the TS-40. Here, in pictures and in the words of the chief engineers, are the reports:

WSOC-TV recommends the TS-40 to any station needing a switching system of high technical performance with excellent possibilities for future expansion.

by L. L. CAUDLE, JR.,* *Chief Engineer, WSOC-TV, Charlotte, North Carolina*



FIG. 1. *L. L. Caudle, Jr., inspecting cross point groups of TS-40 Switching System.

WSOC-TV designed, constructed, and moved into one of the most modern television plants in the Southeast in mid-1959. Early planning included numerous technical conferences with RCA system engineers to be certain that the completed facilities would meet all present requirements and be capable of handling future needs as well.

It was decided to install a new switching system then under development by RCA, the TS-40. This system more than adequately handles the present operating requirements, meets all technical standards required of color and high-quality television picture transmission, and readily adapts itself for future plant enlargement and development.

* See p. 2, note about Mr. Caudle.

The WSOC-TV plant has a master control room, and two live studios with a separate control room for each studio. For the most flexible operation, separate switching systems were installed for each of these control areas.

The studio TS-40 systems have 12 non-composite inputs, 4 composite inputs and 4 outputs. The control panels for these switchers have two special effects banks,

two mixer banks, one preview bank and one line bank. The four composite inputs are on the preview and line banks.

An RCA special effects system, consisting of a TA-25 amplifier, a TG-25 generator and the multiple frequency effects generator, was placed in master control, with remote control panels located in each studio control room. This single system may be switched from one studio control room to the other, as required.

There are two 22-inch consoles in the WSOC-TV master control room operating



FIG. 2. Studio One control panel containing two special effects banks, two mixing banks, one preview bank and one line bank. Special effects selection panel is also incorporated.

position. In the first console is a custom-built, pre-set switcher control panel designed to pre-set two complete audio and video events. This switcher consists of twelve composite inputs and two composite video and audio outputs, with one composite preview output, or third line. Located in the well of this console is a 12-position, audio preview switcher, a remote control panel for sync generators, and gen-lock controls. The second console contains a custom-built, RCA audio control panel. In the well of this console is a control

panel and mixing controls for a 6-input, non-composite TS-40 switcher.

These TS-40 switching systems are contained in four racks in the master control room, making possible short video cables to the associated patch panels, video distribution amplifiers and other equipment. The four racks also house all mixing amplifiers, power supplies and tally relays associated with the system.

The installation of the TS-40 systems was completed in the fall of 1960. During

the interim period from mid-summer of 1959 until the fall of 1960, WSOC-TV operated with three direct video switchers requiring a multitude of video cables running throughout the operations area. The TS-40 systems, with centralized cabling and high technical performance, greatly improved the entire plant operation.

We are very pleased with the over-all performance and reliability of the TS-40 systems, and plan to expand the master control TS-40 switching system to provide switching facilities for video tape recorders.

KERO-TV achieves beautiful switching action with no transients whatsoever.

by AL CROCKER, *Engineering Manager*
KERO-TV, Bakersfield, California

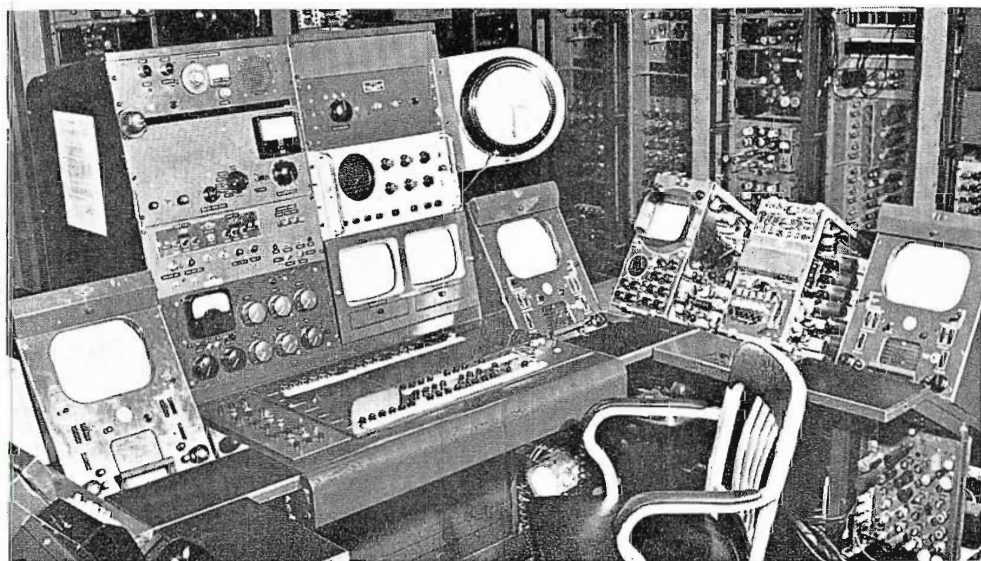

The TS-40 is most satisfactory. Cross-points, latch frames, and push button switches have been trouble-free. Switching action is beautiful, dissolves are very smooth and pre-sets glitch-free

We had the switcher built with future expansion in mind. The effects portion can be added later at very little expense. The holes are already in the panel for the push buttons and a second set of fader levers for horizontal and vertical wipes. We designed and built our own console housing which is pictured. Another panel has been provided here for installation of a remote stop-start panel for projectors and tape recorders, to the left of the switching panel.

FIG. 3. Station-built console housing incorporates TS-40 with room for expansion.

KSTP's three TS-40's handle every switching need.

by FRED STREET, *Director of Engineering Operations*
KSTP-TV, Minneapolis, St. Paul, Minnesota

We have three TS-40 Switchers in use at KSTP. The TS-40 Switcher used for our master control operation in essence includes four complete switchers. Section 1 is master control switching itself, permitting direct selection by the transmitter operator of either control room or of network film, tape, remote, and so on. Section 2 is a duplicate of this except it is run by our automation equipment. Sections 3 and 4 are used as switchers for the inputs to the TRT-1B TV tape recorders.

The two other TS-40 switchers are in service in our two production control rooms. One of these switchers is presently equipped with an RCA special effects system; the second one is designed for use

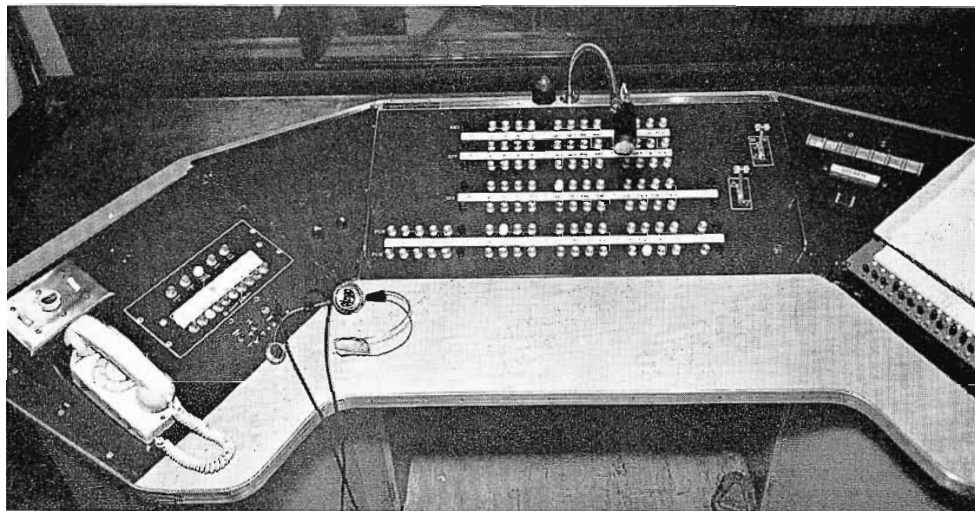

FIG. 4. Control Room Three production switcher. This is a standard TS-40 layout with special effects.

with a special effects system, but the generator has not been installed. However, all the cabling is in place and the second special effects system can literally be installed at a moment's notice.

One of the obvious advantages of the TS-40 is that it is a vertical interval switcher. The fact that no physical relay contacts are involved in switching of course means that we never have contact cor-

rosion to give us poor contact. As far as its general operation is concerned, the TS-40 switcher serves every switching requirement at KSTP. It does a good job and does it quickly.

KOOK-TV gets trouble-free switching since TS-40 was installed two years ago.

by GRANT H. FRENCH, *Chief Engineer*
KOOK-TV, Billings, Montana

Our TS-40 handles 12 inputs . . . composite or non-composite. It accommodates a preview monitor for each video source. It has been trouble-free since we put it into service two years ago.

The transistor design made it possible for us to disassociate ourselves with many of the problems we found in conventional switchers . . . heat problems, contact bounce and so forth. We found the TS-40 convenient and easy to install. All our video source cables go to the equipment rack located remotely from the control panel. The lap-dissolve amplifier is easy to align, very stable, and we've encountered no cross-talk between busses. We like the ability to add more switching circuits should the need arise.



FIG. 5. Grant H. French at the control position of KOOK-TV's 12-input TS-40 Switcher.

KTBS-TV's TS-40 complement custom control.

by CLAUDE SCOTT, *Chief Engineer*
KTBS-TV, Shreveport, Louisiana

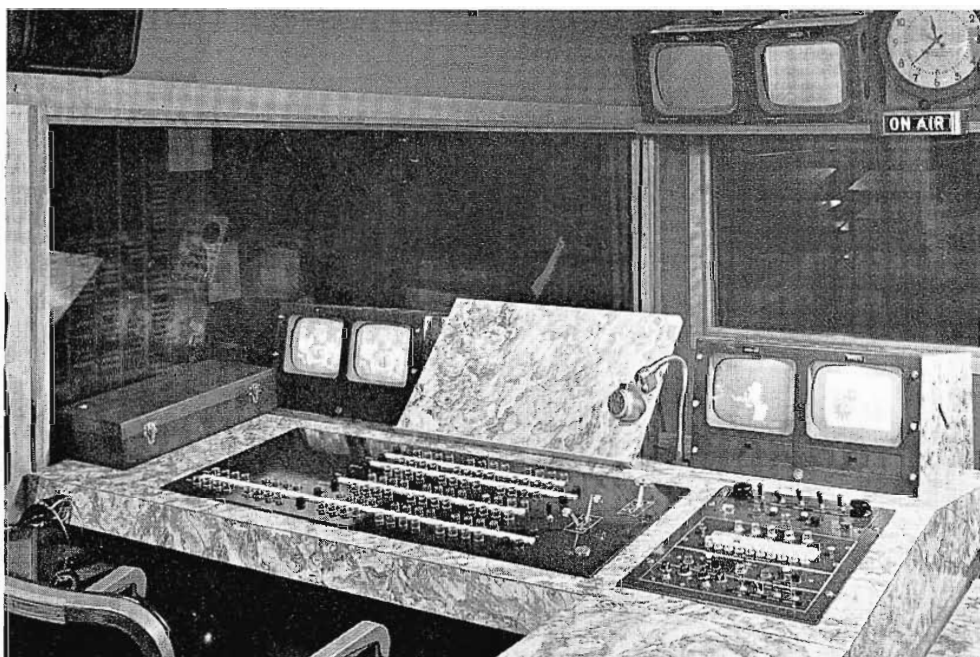

Our switcher is mounted in a console of my design. The console is constructed of wood and covered with a marble formica. An adjustable work-book rack and four eight-inch monitors are mounted directly to the back level of the console. A panel to the right of the TS-40 panel accommodates special effects selection, tv tape recorder, film projector, and slide projector remote control. We find this arrangement convenient, it also adds a stylish accent to our control room.

The system has required very little maintenance and its performance has been very good.

FIG. 6. KTBS custom console, as designed by the author, accommodates TS-40 controls, special effects selection and remote control of tape recorder and projectors.

WBAP-TV finds excellent performance in handling color programs.

by RUPPERT BOGAN, *Chief Engineer*
WBAP-TV, Fort Worth, Texas

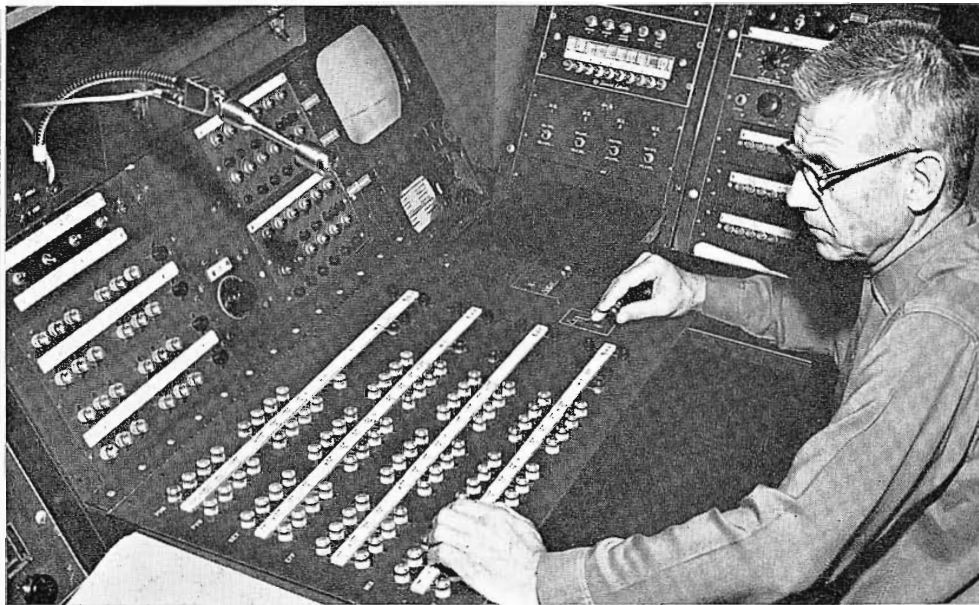

FIG. 7. A 6 by 13 and a 4 by 7 switcher are installed at this control location.

WBAP-TV uses two separate TS-40 systems. One is a 6 by 13 (including the black position). All inputs here are non-

composite. There is one program row, two mixing rows, two effects rows and one combination preview and keying row. The

keying row is used in conjunction with a TA-25 effects amplifier which may be keyed by an external source or TG-25 effects generator.

Another TS-40 system is a 4 by 7 switcher including the black position. This is used for composite switching only—network, tapes and remotes.

Our TS-40 is used extensively for color switching and its excellent performance has been greatly appreciated. We have found production advantages in the flexibility of the system in setting-up keying, laps and effects. Our switching system has been in operation for a year and has been practically trouble free.

We were able to install our TS-40 system in the same physical space formerly occupied by a TS-20 switcher. Due to the plug-in arrangement, the TS-20 was taken out and the TS-40 put in its place in a matter of 4 or 5 hours.

KBTV has been able to handle three different programs simultaneously using TS-40 Switching Systems.

by JAMES H. BUTTS, *Chief Engineer*
KBTV, Denver, Colorado

KBTV uses two TS-40 systems with four control panels: two studio control panels, a TSA-1 preset panel and a 6 by 4 master control panel with audio lock.

These systems have been in continuous daily use for over two years with no maintenance beyond the usual amplifier checks and replacement of one crosspoint. By use of the TSA-1 and special projector control system which eliminates the usual multiplexer and projector start and stop controls, KBTV frequently has been able to operate as many as three different programs with a total studio engineering crew of only twelve men. As an example of this flexibility, each fall we originate several remotes to the network which are blacked out locally; thus necessitating a film show on the air, a five-camera remote to the network, plus television taping of a third program for later playback—all simultaneously.

The TS-40 switcher has been an asset to color operations. KBTV originates ap-

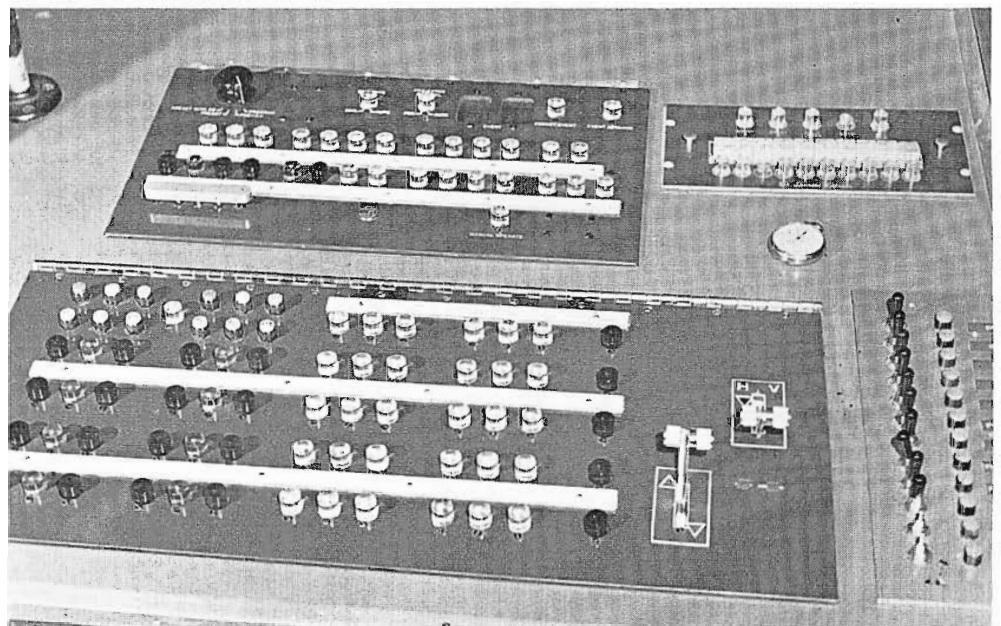

FIG. 8. One of the KBTV TS-40 systems. Top left, TSA-1 Control Panel; top right TG-25 Special Effects Selection; lower right, TS-40 Director's Panel; and lower left, Intercom Control.

proximately three hours per day of film color and our TS-40 has proved to be excellent for color. Through three re-entry

paths the differential gain distortion is not measurable, and the phase distortion is less than 0.5 degrees.

1-KW AM TRANSMITTER WITH SPACE-AGE RELIABILITY

Type BTA-1R1 Transmitter Uses Long-Life Silicon Rectifiers For Reliability
and Tapped-Primary Power Transformer For Power Cutback

by L. S. LAPPIN

Broadcast Transmitter Engineering

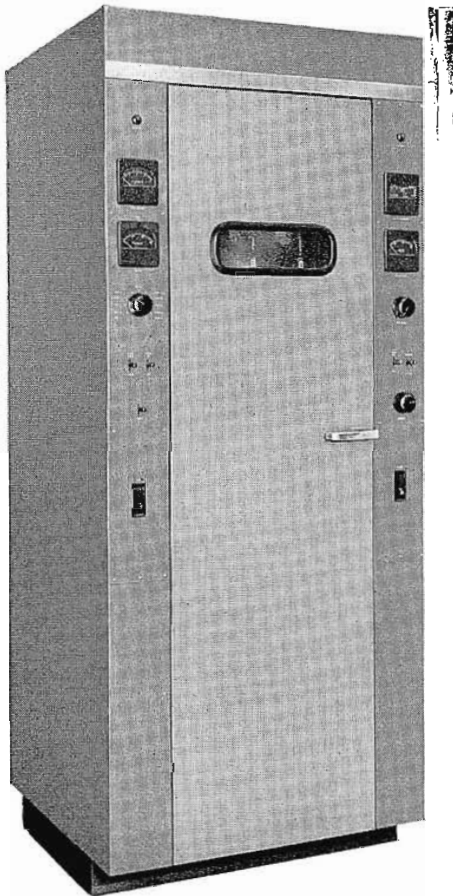

FIG. 1. The complete BTA-1R1 Transmitter. Note simplicity in styling . . . with meters and controls within easy reach.

The Type BTA-1R1 is a truly modern 1-kilowatt AM transmitter that offers unprecedented operational reliability, penny-pinching economy and performance second to none in its class. It is an improved version of the popular Type BTA-1R Transmitter. All of the features which made the Type BTA-1R so well accepted throughout the broadcast industry have been retained and combined with new features that meet today's requirements for 1-kilowatt transmitters.

Silicon Rectifier Dependability

Since the majority of the 1-kw AM stations now operate via remotely-controlled transmitters, continuity of transmitter operation is more important than ever before. Mercury-vapor rectifier tubes—with their

tendency to arc-back and sensitivity to ambient temperatures—no longer meet the broadcasters' requirements for reliability. This is the reason that the Type BTA-1R1 employs silicon rectifiers in all three of its power supplies. Silicon rectifiers require no attention other than an occasional measurement of the reverse resistance with an ordinary ohmmeter.

Operating Economy

There are several reasons for the outstanding operating economy the Type BTA-1R1 offers its users. First, the transmitter requires—for most localities—no building-heating system as the direct result of silicon rectifiers and the temperature-controlled crystals. There is, however, one qualification: the minimum ambient temperature—at start-up—must be greater than -4°F . . . this value is the lower operating-temperature limit of the silicon rectifiers. Thus, in most parts of the world, the transmitter room needs no heating system.

Second, the Type BTA-1R1 uses primary power in a very conservative manner. The silicon rectifiers operate without filament power and the power-cutback system eliminates power-wasting dropping resistors . . . thus reducing primary-power requirements.

Third, the BTA-1R1 keeps spare-parts inventories—and investment—at minimum: the transmitter uses only 5 tube types and each tube's operating parameters were selected for maximum tube life at top performance. The single silicon-rectifier type permits reduced investment in spare parts; the excellent derating of all components within the transmitter assures long, trouble-free life.

The compact—yet completely accessible—mechanical design results in floor-space savings that can be measured in dollars and cents of operating cost.

Accessible Mechanical Design

A single, aluminized-steel cabinet houses the entire transmitter. The mechanical design precludes the possibility of hidden or otherwise-inaccessible components. An average-sized man can reach—and repair

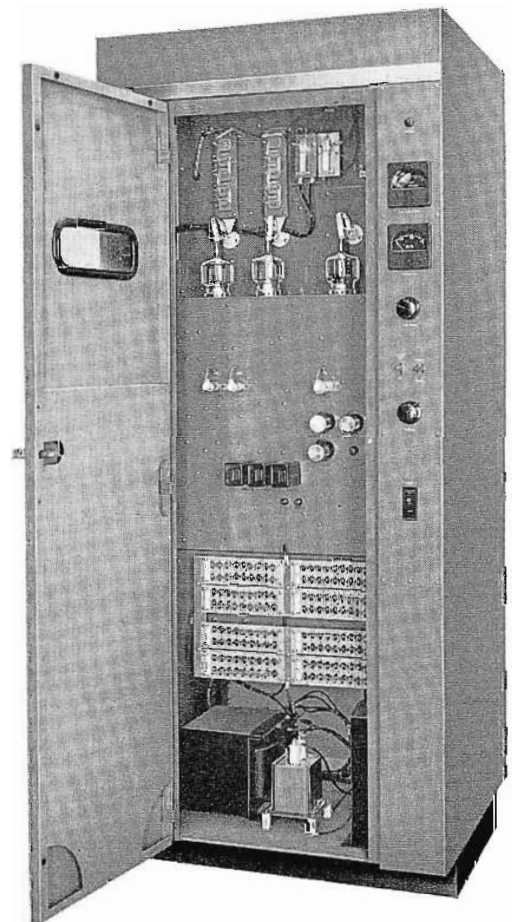

FIG. 2. Note uncrowded layout for ease of maintenance. Transformers on cabinet floor; silicon rectifiers immediately above; oscillator, IPA and audio amplifier in center; modulator and PA power tubes near top.

or replace—any component within the cabinet. The larger transformers, chokes, capacitors, etc. are neatly arranged on the cabinet floor; all other parts are easily accessible from either the front or the rear of the transmitter cabinet. (Removable panels at the rear; hinged, full-length door at front—see photos.)

Forced-air cooling, through a plenum-chamber distribution system, supplies cooling air to the power-tube bases.

Temperature-Controlled Crystal Oscillator

The oscillator section, including the buffer amplifier, is a removable, etched-

wiring, dip-soldered panel that provides for three temperature-controlled crystals of the plug-in type: One "operating"; one "stand-by" and one "Conelrad". A switching arrangement allows instantaneous crystal change in the event of crystal failure or a Conelrad alert. This is performed through a front-panel switch or through remote control equipment (such as the RCA Type BTR-11B or BTR-20B).

The temperature-controlled crystals are completely unaffected by ambient temperatures. They are the ideal choice for silicon-rectifier-equipped transmitters. The combination of the two permits transmitter operation in unheated, indoor surroundings in temperatures down to -4 F.

The oscillator uses a Type 6AK5 pentode operated at very low cathode current to assure long, dependable life. The buffer amplifier uses a Type 5763 pentode and is resistance coupled to the intermediate power amplifier (IPA) Type 6146 beam tetrode. The sampling signal for the frequency monitor comes from the cathode of this IPA. The plate load for the IPA is a broadly-tuned inductance adjustable for any frequency in the broadcast band.

Stable, Screen-Grid PA

The power amplifier is a paralleled pair of Type 4-400A power tubes driving a double-pi network with a 2nd harmonic trap. This trap limits spurious radiation—at any harmonic—to 73db below carrier.

Since all capacitors are sealed, fixed-value mica units, tuning is performed through variable inductance. The tuning device is a silver-plated, copper cylinder which slug-tunes the coil. This movement is through a front-panel control.

Slug-tuning eliminates the resistance problems inherent in sliding-contact coil-tuning systems. Further, inductance tuning reduces the required number of capacitors in the circuit thereby adding, measurably, to overall reliability.

The Type BTA-1R1 operates without r-f amplifier neutralization at any stage owing to the use of screen-grid tubes throughout the r-f chain. This design assures complete amplifier stability and increased power gain per stage with its resulting reduction in tube-replacement costs. Conservation in each stage's operating parameters adds much to the long-term reliability of the transmitter.

One-Stage Audio; Class AB₁ Modulator

The audio amplifier is a push-pull system employing the distortion-free Type

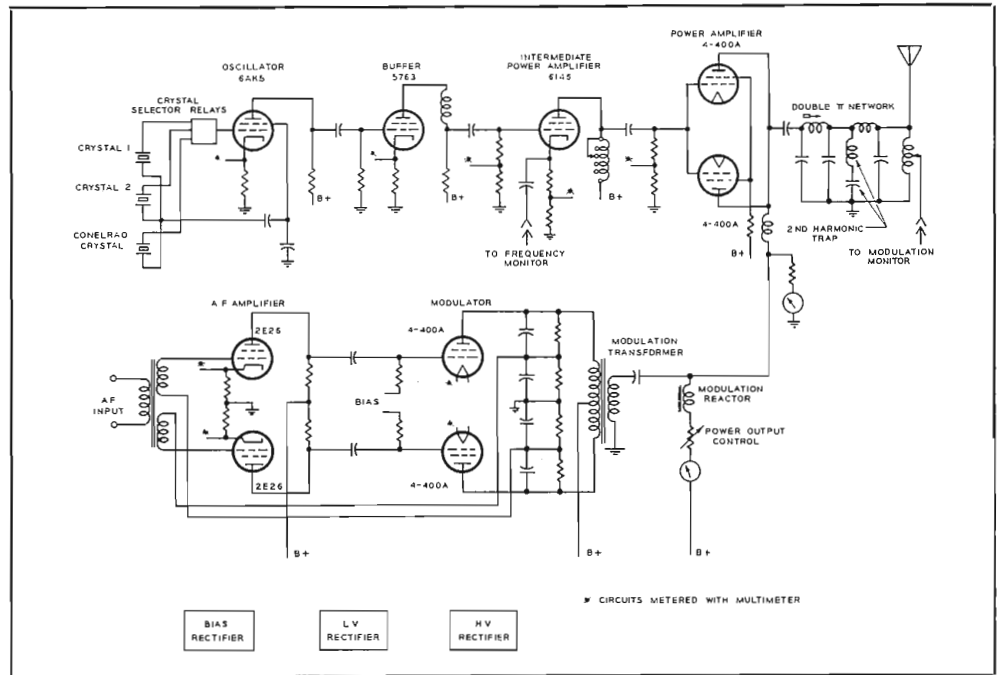

FIG. 3. Simplified circuit schematic, BTA-1R1. Note that only one power-tube type is used; only nine tubes in entire transmitter . . . of only five types.

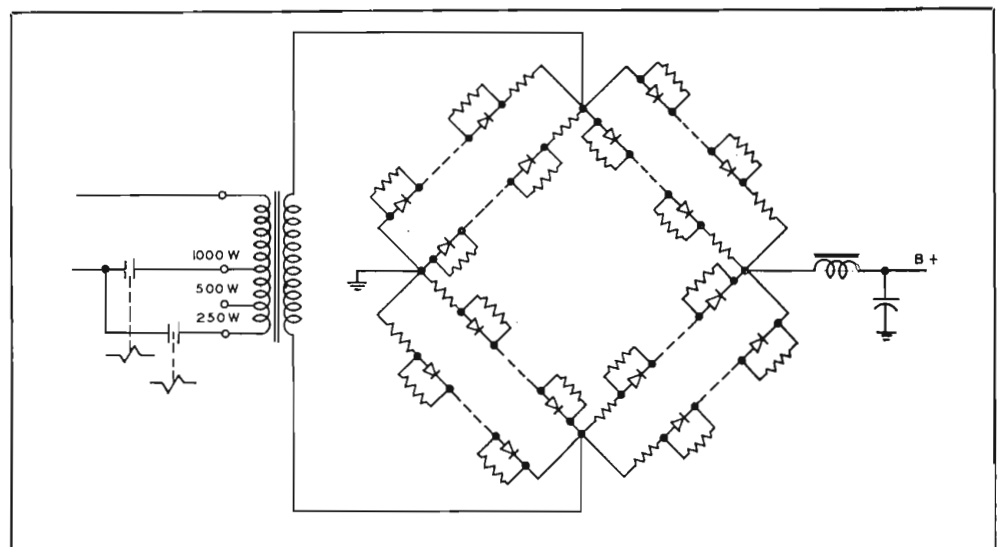

FIG. 4. Simplified schematic diagram of silicon-rectifier high-voltage power supply. Note series-parallel arrangement with voltage-sharing resistors, the series current-limiting resistors and the choke-input filter.

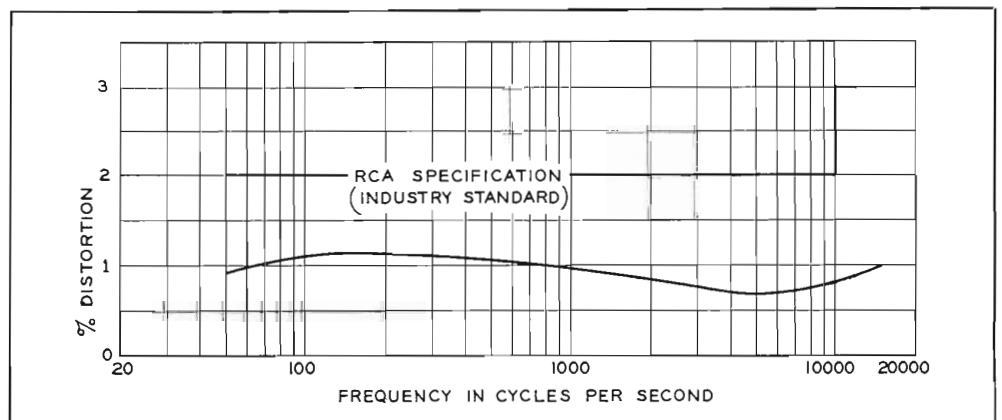

FIG. 5. Typical distortion vs. frequency curve. Note that distortion at maximum is only slightly more than half of the industry-standard specification.

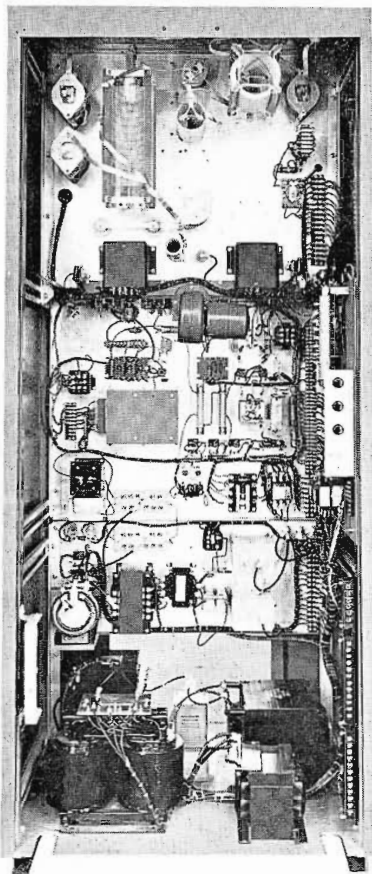

FIG. 6. Rear view. Note clear accessibility to all components. Laced wiring harnesses and screw-type terminal strips make for easy maintenance.

2E26. These are resistance coupled to a pair of Type 4-400A beam-power amplifiers operating—without grid current—in Class AB₁. This eliminates a driver stage and, at the same time, reduces audio distortion to insignificance. Full, two-stage inverse feedback controls amplifier linearity to within tight tolerances and adds much to the stability of the audio system.

Modulation of the power amplifier is accomplished in the plate and screen circuits—the screen self-modulated—to provide 110 per cent modulation capability.

Silicon Power Supplies

Three separate d-c power supplies serve the transmitter's power needs. These supplies use silicon rectifiers with their advantage of proven long-life and trouble-free operation. The same diode type, an RCA 1N2862, serves in all three supplies. This reduces spare-parts inventories of this component to a single type.

In the high-voltage supply, a series-parallel bridge arrangement—with "bleeder" resistors—maintains peak-inverse voltage (PIV) and forward current well within rated values. The "bleeder" resistors prevent build-up of PIV across any one rectifier owing to the change (through aging)

of the reverse resistance of any of the remaining diodes in the bridge leg. The paralleling arrangement assures ample current capabilities during starting transients or powerline surges. The overall result is a current-reserve factor in excess of 200 per cent and a PIV-derating factor of more than 50 per cent on each of the diodes in the power supplies.

Many Protection Devices

High-speed, adjustable-threshold overload relays protect the transmitter's tubes and components from damage in the event of an antenna-system arc-over or other load-increasing fault. These relays automatically disconnect the low- and high-voltage power supplies from the transmitter and open the cathode circuits of the PA and modulator tubes.

Filament and main-line circuit breakers monitor currents in their respective circuits. A time-delay circuit breaker controls the cooling-blower motor power for a delay at start-up (to help tubes reach temperature quickly) and after shutdown (to carry off residual heat left in the tubes).

Tapped-Primary Power Cutback

The BTA-1R1 employs a tapped-primary plate-power transformer for day/night operation. This transformer eliminates the power-wasting series-dropping resistors often used for power cutback.

At the purchaser's option, the power-cutback feature is arranged for daytime power of 1 kw and a nighttime power of either 500 or 250 watts. Simple, straightforward design permits rearrangement of these transformer connections (after installation) should there be future changes in day/night operational prerequisites. Once arranged, power cutback is a simple flick of a single, front-panel, "DAY-NIGHT" toggle switch. The important point is that

this method of cutback causes no transmitter shutdown or interruption in programming.

Built-In Remote-Control

The relays, wiring, etc. necessary for complete remote-control operation are included in the Type BTA-1R1 design. These include a motorized output control, a latching relay and the appropriate meter shunts. A BTR-11B or BTR-20B Remote-Control Equipment is the only additional gear needed to control the transmitter via a low-cost "telephone pair." Thus, the BTA-1R1 requires no internal modifications for remote-control operation.

Conelrad Facilities

The Type BTA-1R1 design includes all provisions for the installation of an optional Conelrad kit for almost instantaneous switch-over to (or from) the appropriate Conelrad frequency either locally—through a front-panel toggle switch—or remotely, through the remote-control facilities described above. The oscillator section provides a prewired socket for the Conelrad crystal and includes the appropriate latching relays for remote-controlled switchover.

Improves Station Performance

Summarizing, the Type BTA-1R1 transmitter is the ideal choice for any 1-kw station . . . whether it be the long-established kilowatt seeking to upgrade the "sound" of the facility or, the new "spot on the dial" where, until billings reach planned levels, every penny of operating costs count against profitable operation.

The transmitter uses virtually every proven engineering innovation to assure its users of high performance, maximum operating economy and long, useful life with only minimum maintenance. As a result, the Type BTA-1R1 is truly one of the world's finest 1-kw transmitters.

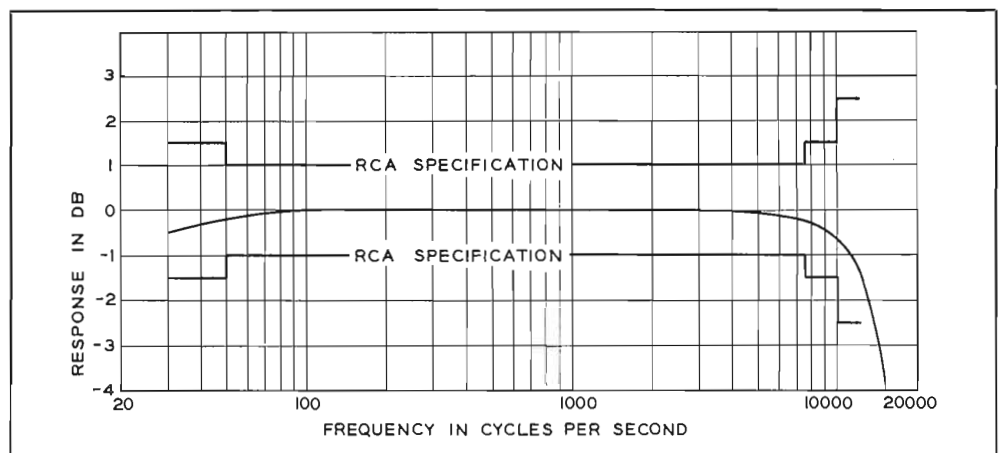
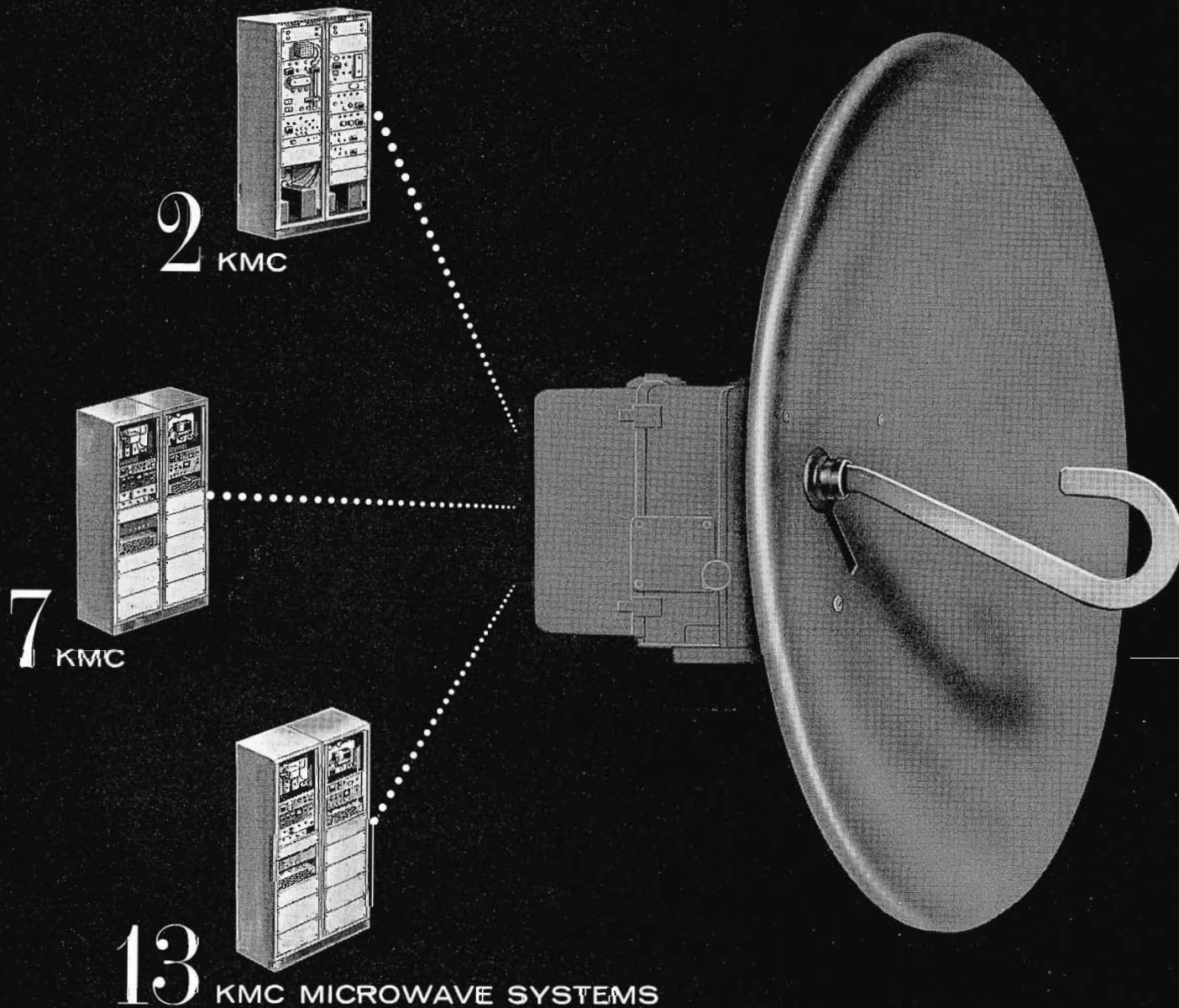

FIG. 7. Typical frequency-response characteristic, BTA-1R1. Note that response is well within RCA specifications and these are well within industry standards. Note also the smooth roll-off to 30 cps and 10 kc. Truly, high-fidelity AM "sound".



Whatever Frequency You Need... RCA Has the Microwave System to Do the Job

Here's a full line of equipment, excellent for all television microwave applications. Whatever use you have in mind, whatever frequency suits your need, you can get a complete system from RCA. It will be tailored to your own job specifications.

2 KMC -TYPE TVM-22. Offers the very finest specifications available to the microwave user. Gives excellent performance for color signals over long-haul inter-city routes. "Top-of-the-Line" equipment.

7 KMC -TYPE TVM-1B. This 7000 MC equipment is the standard of the industry. Now in use in over 700

installations. For color signals, STL, inter-city routes and remotes. Broadcast and common carrier applications.

13 KMC -TYPE TVM-3A. This new 13,000 MC equipment is fine for intra-city links and for broadcast STL. Also recommended for private business applications.

Rack mounted and portable systems are available. Also reversible, diversity, fault locating and reporting features. RCA has the experience and equipment to give you the greatest assistance and widest choice. Consult your RCA representative. Or write to RCA Broadcast and Television Equipment, Building 15-5, Camden, N. J.

WIDEST CHOICE OF EQUIPMENT • THREE FREQUENCY BANDS • COLOR AND MONOCHROME



The Most Trusted Name in Television

New RCA Cartridge Tape System with "TRIP CUE"



Here's the cartridge tape system with something new—*trip cue!* This unique feature allows you to record a special trip-cue tone that, during playback, can be used to start the next device in an automatic or semi-automatic system, with split-second timing. (In TV operations it may be used to advance slide projectors.)

Delayed broadcast, spot announcement campaigns, production aids, themes, station breaks can be handled by the RT-7A with a minimum of effort. Cartridge is selected, placed in a playback unit, forgotten until "Air" time, then instantly played at the flick of a button. Cueing and threading are eliminated.

Check this handsomely-styled equipment against any other for compactness and design... Provides transistor circuitry, low power consumption, simplicity of operation! It's one more in a growing line of value-packed new products for radio and television stations from the pioneer in broadcasting. See your RCA Broadcast Representative. Or write to RCA Broadcast and Television Equipment, Building 15-5, Camden, N. J.

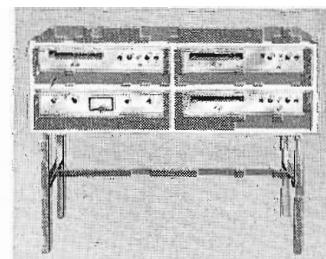

Typical packaging is this attractive four-unit console with single BA-7 Cartridge Tape Record and Playback Amplifier and three Cartridge Tape Decks, as illustrated.

Separate units of this system available are the Record and Playback Amplifier, and the Cartridge Tape Deck. A Cartridge Storage Rack is also available.



The Most Trusted Name in Electronics



The Mark of Success in Station Planning

The RCA monogram has been a guide to selection of the best in broadcast equipment and services for over 30 years.

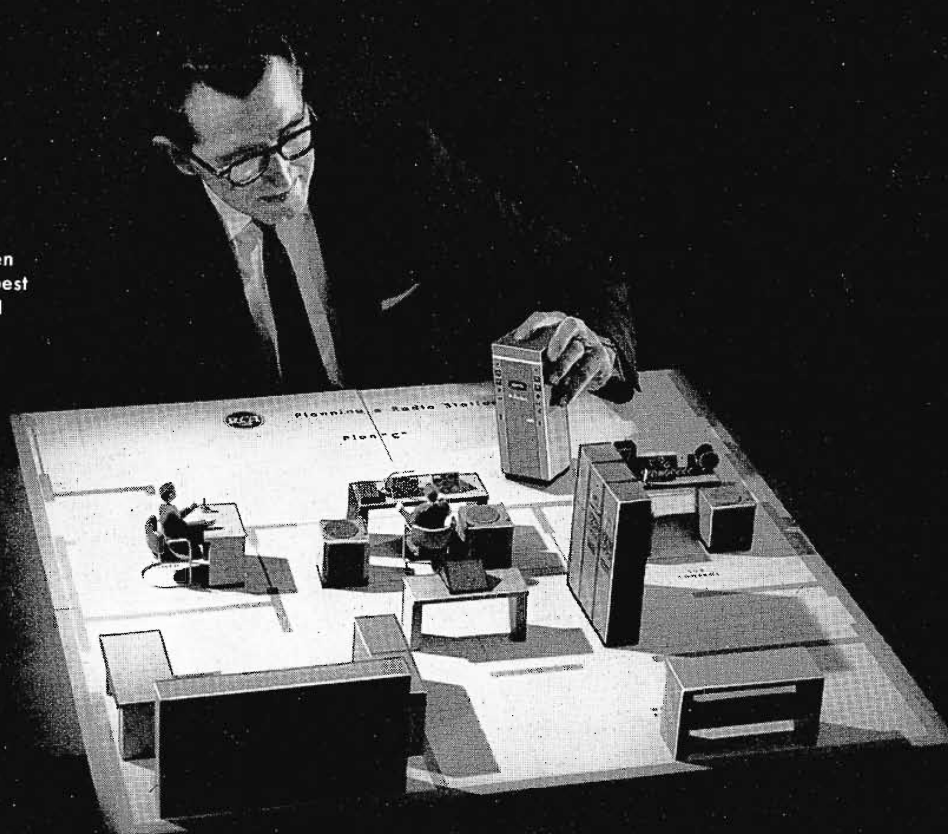

The Most Trusted Name in Electronics

Broadcasters, TV Tape Services,
Producers of Tape Commercials and Programs
gain a big, new dimension in color

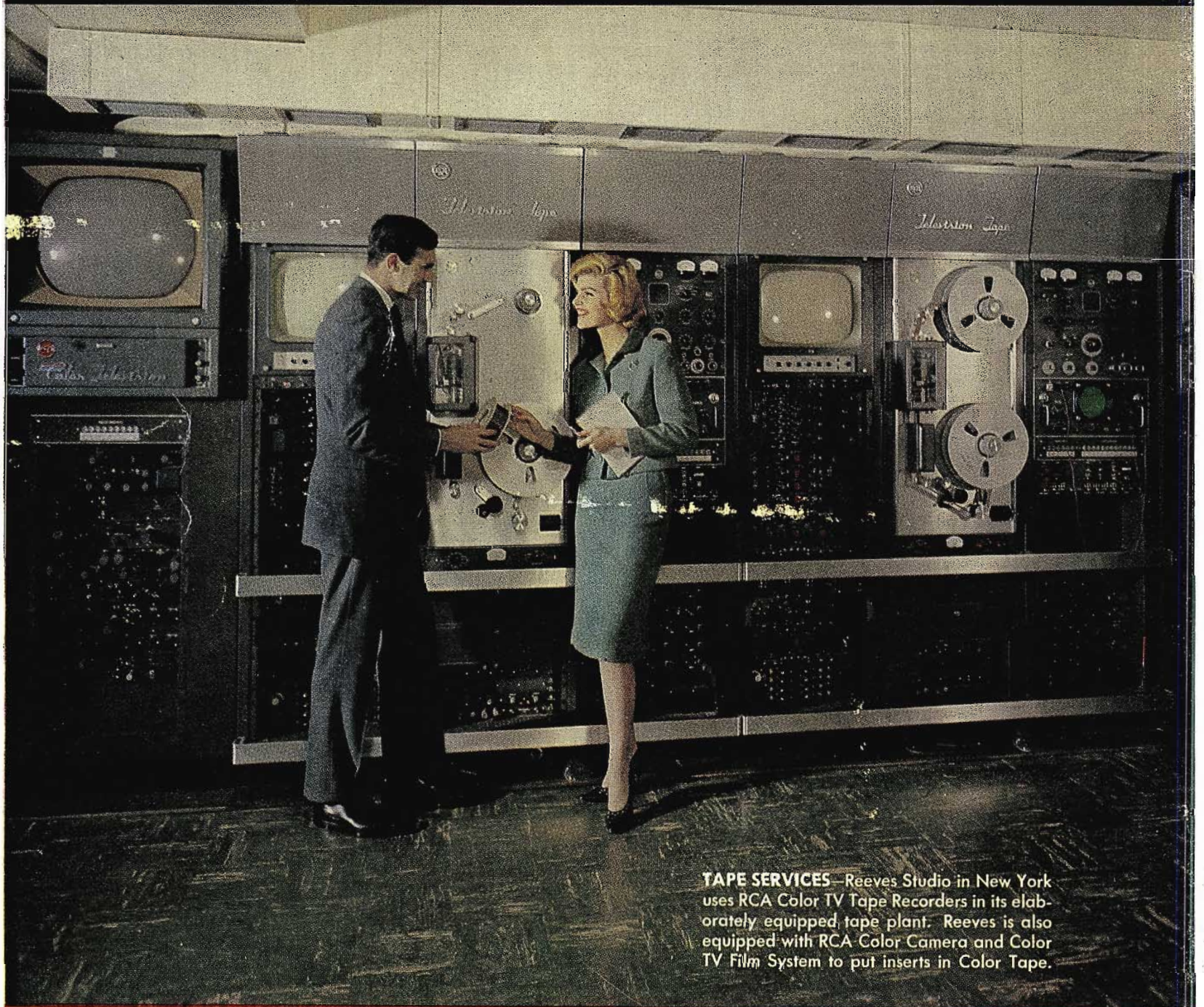

TAPE SERVICES—Reeves Studio in New York uses RCA Color TV Tape Recorders in its elaborately equipped tape plant. Reeves is also equipped with RCA Color Camera and Color TV Film System to put inserts in Color Tape.

... using Color TV Systems
designed by RCA